

Pressure Transmitter for Precision Measurement

Model P-30, standard version

Model P-31, flush diaphragm

WIKA Data Sheet PE 81.54

Applications

- Test benches
- Calibration technology
- Laboratories and Maintenance shops
- Machine building

Special Features

- Accuracy: 0.1 % without additional temperature error in the range 10 ... 60 °C / 50 ... 140 °F
- Fast external measuring rate for data acquisition up to 1 kHz
- Compact design
- Easy PC connection for calibration and adjustment via USB interface

Beschreibung

High precision

By using the proven WIKA pressure sensors, precise measurements are ensured, with a maximum possible measuring deviation of up to 0.05 %. As proof of this, each instrument comes with a test report, free of charge. Alternatively, if wanted, a 3.1 acceptance test certificate or a DKD certificate can be gladly provided. In addition, they have excellent values for the non-linearity of the characteristic line and long-term stability.

Fast digital data processing

Active temperature compensation of the instrument is enabled by complex precise digital signal processing via microcontroller as well as internal temperature measurement. Thus, in the operating range of 10 ... 60 °C / 50 ... 140 °F, no additional temperature errors occur. Nevertheless, an exceptionally fast measuring and output rate of 1 ms is available, comparable with analogue pressure transmitters.



Fig. Pressure transmitter P-30

With an internal USB service interface and optional EasyCom 2009 configuration software the P-3X can be calibrated quickly and comfortably. Beyond that, the possibility exists to adjust zero point and span.

Compact design

Due to their robust, compact design, the pressure transmitters can be integrated, simply and space-saving, into a 19" rack or into a system. With the combination of male and female threads fitting can be achieved both exceptionally quickly and safely, which avoids further seals.

Large variation

Measuring ranges are available from 250 mbar to 1,000 bar, vacuum, absolute pressure and in various country-specific units. With the Model P-31, additionally, a flush diaphragm version is available for critical media or for ease-of-cleaning. The large choice of electrical connections and analogue output signals completes the program for this series.

Specifications

Model P-30 / P-31

Pressure ranges	bar	0.25	0.4	0.6	1	1.6	2.5	4	6	10	16	
Over pressure safety	bar	2	2	4	5	10	10	17	35	35	80	
Burst pressure	bar	2.4	2.4	4.8	6	12	12	20.5	42	42	96	
Pressure ranges	bar	25	40	60	100	160	250	400	600	1000 ¹⁾		
Over pressure safety	bar	50	80	120	200	320	500	800	1200	1500		
Burst pressure	bar	96	400	550	800	1000	1200	1700 ²⁾	2400 ²⁾	3000		
{Vacuum, gauge pressure, compound range, absolute pressure are available}												
{compound ranges: minimum span 400 mbar, z.B. -200 mbar ... +200 mbar}												
¹⁾ Only Model P-30.												
²⁾ For Model P-31: the value specified in the table applies only when sealing is realised with the sealing ring underneath the hex. Otherwise max. 1500 bar applies.												
Materials												
■ Wetted parts												
» Model P-30	Stainless steel (pressure ranges > 25 bar additional 2.4711 / UNSR 30003)											
» Model P-31	Stainless steel; O-Ring: NBR {FPM/FKM or EPDM}											
■ Case	Stainless steel											
Internal transmission fluid ³⁾	Synthetic oil											
³⁾ Not for P-30 with pressure ranges > 25 bar												
Power Supply U+	U+ in VDC	9 ... 30 (14 ... 30 with signal output 0 ... 10 V)										
Signal output and maximum load RA	RA in Ohm	4 ... 20 mA, 2-wire					RA ≤ (U+ - 9 V) / 0.02 A					
		0 ... 20 mA, 3-wire					RA ≤ (U+ - 9 V) / 0.02 A					
		4 ... 20 mA, 3-wire					RA ≤ (U+ - 9 V) / 0.02 A					
		0 ... 5 V, 3-wire					RA > 5 k					
		0 ... 10 V, 3-wire					RA > 10 k					
Adjustability												
■ zero	% of span	-5 ... +20 {adjustment via software EasyCom 2009}										
■ span	% of span	-20 ... +5 {adjustment via software EasyCom 2009}										
Measuring rate	ms	1 (with 3-wire); 2 (with 2-wire)										
Warm-up time	min	< 10										
Insulation voltage	VDC	500										
Accuracy ⁵⁾	% of span	≤ 0.10 in the range 10 ... 60 °C / 50 ... 140 °F {< 0.05 at 20 °C / 68 °F} ⁶⁾										
⁵⁾ Including non-linearity, hysteresis, zero point and full scale error (corresponds to error of measurement per IEC 61298-2). Adjusted in vertical mounting position with lower pressure connection.												
⁶⁾ Cannot be manufactured for: compound ranges and pressure ranges ≤ 0.4 bar.												
Non-linearity	% of span	≤ 0.04					(BFSL) according to IEC 61298-2					
1-year stability	% of span	≤ 0.1					(at reference conditions)					
Permissible temperature of												
■ Medium		-20 ... +105 °C					-4 ... +221 °F					
■ Ambience		-20 ... +80 °C					-4 ... +176 °F					
■ Storage		-40 ... +85 °C					-40 ... +185 °F					
Rated temp. range		-20 ... +80 °C					-4 ... +176 °F					
Temperature coefficients within rated temp range	(the temperature related deviations in the range 10 ... 60 °C (50 ... 140 °F) are already covered by the accuracy above)											
■ Mean TC of zero	% of span	≤ 0.1 / 10 K										
■ Mean TC of range	% of span	≤ 0.1 / 10 K										
RoHS-conformity	Yes (not possible with bajonet connector)											
CE-conformity												
■ Pressure equipment directive	97/23/EC											
■ EMC directive	2004/108/EEC, EN 61 326 Emission (Group 1, Class B) and Immunity (industrial locations)											
Shock resistance	g	200 according to IEC 60068-2-27					(mechanical shock)					
Vibration resistance	g	10 according to IEC 60068-2-6					(vibration under resonance)					
Wiring protection												
■ Short-circuit proofness	S+ towards U-											
■ Reverse polarity protection	U+ towards U-											
Weight	kg	Approx. 0.3										

{ } Items in curved brackets are optional extras for additional price.

Dimensions in mm

Circular connector
M12x

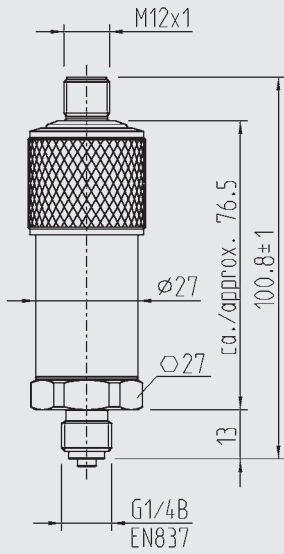

Bayonet connector

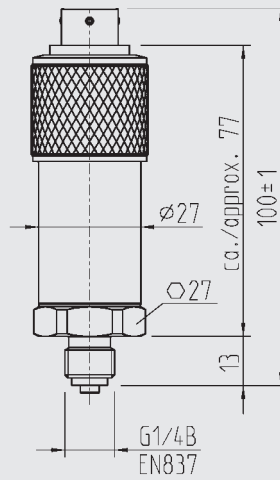

Flying leads

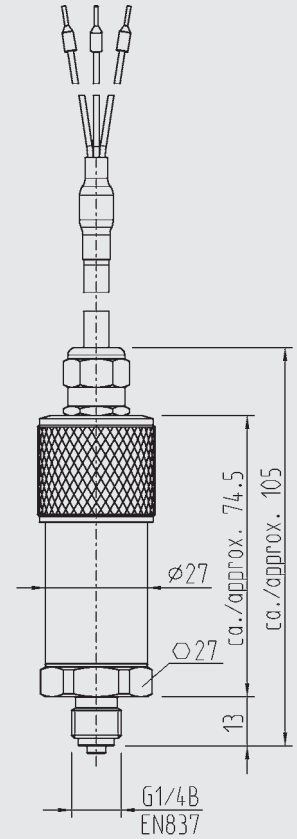

Circular connector
M 16x0.75

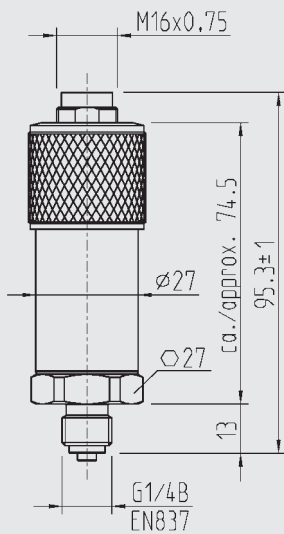

L-connector
DIN 175301-803 A

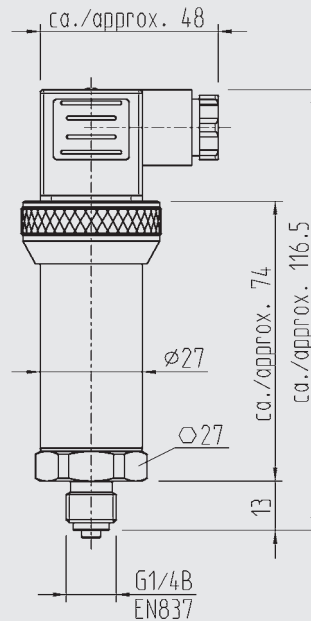

For installation and safety instructions see the operating instructions for this product.

For tapped holes and welding sockets please see Technical Information IN 00.14 for download at www.wika.de -Service

Pressure connections P-30

G 1/2

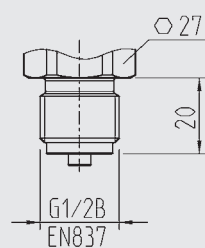

G 1/4

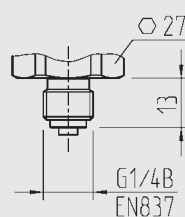

G 1/2 male /
G 1/4 female

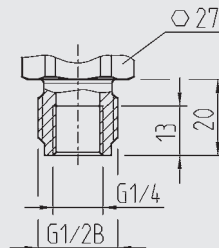

G 1/4 female
EN 837
with sealing copper
{stainless steel}

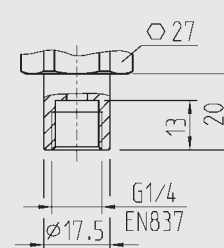

1/2 NPT
per „Nominal size for US
standard tapered pipe
thread NPT“

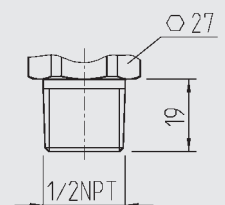

Pressure connection P-30

1/4 NPT
per „Nominal size for US
standard tapered pipe
thread NPT“

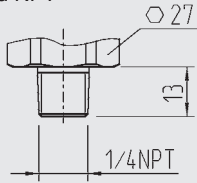

Pressure connections P-31, flush diaphragm

G 1B
0 ... 0.25 up to 0 ... 1.6 bar

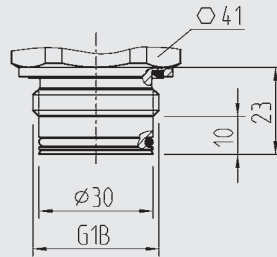

G 1/2 B
0 ... 2.5 up to 0 ... 600 bar

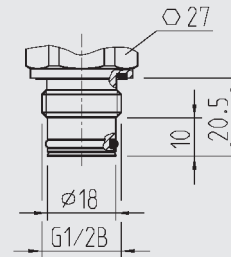

Others on request

Electrical connections

	L-connector DIN 175301-803 A	Circular connector M12x1, 4-pins	Flying leads	Bayonet connector, 6-pins	Circular connector M16x0.75, 5-pins
2-wire	U+ = 1 U- = 2	U+ = 1 U- = 3	U+ = brown U- = blue	U+ = A U- = B	U+ = 3 U- = 1
3-wire	U+ = 1 U- = 2 S+ = 3	U+ = 1 U- = 3 S+ = 4	U+ = brown U- = blue S+ = black	U+ = A U- = B S+ = C	U+ = 3 U- = 4 S+ = 1
Cable screen	-	-	grey	-	-
Wire gauge	up to max. 1.5 mm ²	-	0.5 mm ² (AWG 20)	-	-
Cable diameter	6-8 mm	-	6.8 mm	-	-
Ingress Protection per IEC 60 529	IP 65	IP 67	IP 67	IP 67	IP 65
The ingress protection classes specified only apply while the pressure transmitter is connected with female connectors that provide the corresponding ingress protection.					

Accessories

Order-No.

USB adaptor cable incl. Software EasyCom 2009 for internal service interface

13193075

Specifications and dimensions given in this leaflet represent the state of engineering at the time of printing. Modifications may take place and materials specified may be replaced by others without prior notice.



WIKAI Alexander Wiegand SE & Co. KG
Alexander-Wiegand-Straße 30
63911 Klingenberg/Germany
Tel. (+49) 9372/132-0
Fax (+49) 9372/132-406
E-mail info@wika.de
www.wika.de