

# Mixed-Signal Oscilloscope

MSO-2000E & MSO-2000EA

---

**USER MANUAL**



ISO-9001 CERTIFIED MANUFACTURER

**GW INSTEK**

September 2016

This manual contains proprietary information, which is protected by copyright. All rights are reserved. No part of this manual may be photocopied, reproduced or translated to another language without prior written consent of Good Will company.

The information in this manual was correct at the time of printing. However, Good Will continues to improve products and reserves the rights to change specification, equipment, and maintenance procedures at any time without notice.

**Good Will Instrument Co., Ltd.**  
No. 7-1, Jhongsing Rd., Tucheng Dist., New Taipei City 236, Taiwan

# Table of Contents

<b>SAFETY INSTRUCTIONS .....</b>	<b>7</b>
<b>GETTING STARTED.....</b>	<b>12</b>
MSO-2000E/2000EA Series Overview ...	14
Appearance.....	18
Set Up.....	31
Built-in Help .....	41
<b>MEASUREMENT .....</b>	<b>42</b>
Basic Measurement .....	43
Automatic Measurement.....	50
Cursor Measurement .....	65
Math Operation .....	73
<b>ADVANCED CONFIGURATION .....</b>	<b>83</b>
Acquisition .....	86
Segmented Memory Acquisition .....	91
Display.....	103
Horizontal View .....	108
Vertical View (Channel).....	116
Bus Key Configuration.....	124
Trigger .....	151
Search.....	193
System Settings and Miscellaneous Settings .....	202
<b>LOGIC ANALYZER.....</b>	<b>207</b>
Logic Analyzer Operation.....	208
<b>ARBITRARY WAVE GENERATOR .....</b>	<b>223</b>
Arbitrary Wave Generator Operation ..	224

**APPLICATIONS** ..... **258**

- Introduction ..... 259
- Go-NoGo application ..... 261
- DVM application ..... 266
- Data Log application ..... 268
- Digital Filter application ..... 270
- Mask application..... 272

**SAVE/RECALL** ..... **282**

- File Format/Utility ..... 283
- Create/Edit Labels..... 289
- Save ..... 292
- Recall ..... 300
- Reference Waveforms ..... 306

**FILE UTILITIES** ..... **308**

- File Navigation ..... 309
- Create Folder..... 311
- Rename File ..... 312
- Delete File or Folder ..... 313
- Copy File to USB ..... 314

**HARDCOPY KEY** ..... **315**

**REMOTE CONTROL CONFIG** ..... **319**

- Interface Configuration ..... 320

**MAINTENANCE** ..... **330**

**FAQ**..... **336**

**APPENDIX**..... **339**

- Updating the Firmware ..... 340
- MSO-2000E/2000EA Specifications ... 342
- Probe Specifications ..... 347

Dimensions .....	349
Declaration of Conformity.....	350
<b>I</b> NDEX.....	<b>351</b>



# S SAFETY INSTRUCTIONS

This chapter contains important safety instructions that you must follow during operation and storage. Read the following before any operation to insure your safety and to keep the instrument in the best possible condition.

## Safety Symbols

These safety symbols may appear in this manual or on the Product name.

---



WARNING

Warning: Identifies conditions or practices that could result in injury or loss of life.



CAUTION

Caution: Identifies conditions or practices that could result in damage to the equipment or to other properties.



DANGER High Voltage



(Note)

Attention required  
Refer to the Manual



Protective Conductor Terminal



Earth (ground) Terminal



Do not dispose electronic equipment as unsorted municipal waste. Please use a separate collection facility or contact the supplier from which this instrument was purchased.

## Safety Guidelines

---

### General Guideline



WARNING



CAUTION

- Make sure the BNC input voltage does not exceed 300Vrms.
- Never connect a hazardous live voltage to the ground side of the BNC connectors. It might lead to fire and electric shock.
- Do not place any heavy object on the MSO-2000E/2000EA.
- Avoid severe impact or rough handling that leads to damaging the MSO-2000E/2000EA.
- Do not discharge static electricity to the MSO-2000E/2000EA.
- Use only mating connectors, not bare wires, for the terminals.
- Do not block the cooling fan opening.
- Do not perform measurement at a power source or building installation (Note below).
- Do not disassemble the MSO-2000E/2000EA unless you are qualified.



Note

(Measurement categories) EN 61010-1:2010 specifies the measurement categories and their requirements as follows. The MSO-2000E/2000EA falls under category I.

- Measurement category IV is for measurements performed at the source of low-voltage installation.
  - Measurement category III is for measurements performed in the building installation.
  - Measurement category II is for measurements performed on circuits directly connected to the low voltage installation.
  - Measurement category I is for measurement performed on circuits not directly connected to Mains.
-



- Power Supply
- AC Input voltage: 100 - 240V AC, 50 - 60Hz, auto selection. Power consumption: 40 Watts.
  - Connect the protective grounding conductor of the AC power cord to an earth ground, to avoid electrical shock.
- 

- Cleaning the MSO-2000E
- Disconnect the power cord before cleaning.
  - Use a soft cloth dampened in a solution of mild detergent and water. Do not spray any liquid.
  - Do not use chemicals containing harsh materials such as benzene, toluene, xylene and acetone.
- 

- Operation Environment
- Location: Indoor, no direct sunlight, dust free, almost non-conductive pollution (Note below)
  - Relative Humidity:  $\leq 80\%$ ,  $40^{\circ}\text{C}$  or below;  $\leq 45\%$ ,  $41^{\circ}\text{C} \sim 50^{\circ}\text{C}$
  - Altitude:  $< 2000\text{m}$
  - Temperature:  $0^{\circ}\text{C}$  to  $50^{\circ}\text{C}$



(Pollution Degree) EN 61010-1:2010 specifies the pollution degrees and their requirements as follows. The MSO-2000E/2000EA falls under degree 2.

Pollution refers to “addition of foreign matter, solid, liquid, or gaseous (ionized gases), that may produce a reduction of dielectric strength or surface resistivity”.

- Pollution degree 1: No pollution or only dry, non-conductive pollution occurs. The pollution has no influence.
  - Pollution degree 2: Normally only non-conductive pollution occurs. Occasionally, however, a temporary conductivity caused by condensation must be expected.
  - Pollution degree 3: Conductive pollution occurs, or dry, non-conductive pollution occurs which becomes conductive due to condensation which is expected. In such conditions, equipment is normally protected against exposure to direct sunlight, precipitation, and full wind pressure, but neither temperature nor humidity is controlled.
-

**Storage environment**

- Location: Indoor
  - Temperature: -10°C to 60°C
  - Humidity: Up to 93% RH (non-condensing) / ≤40°C, up to 65% RH (non-condensing) / 41°C ~ 60 °C
- 

**Disposal**

Do not dispose this instrument as unsorted municipal waste. Please use a separate collection facility or contact the supplier from which this instrument was purchased. Please make sure discarded electrical waste is properly recycled to reduce environmental impact.

## Power cord for the United Kingdom

When using the oscilloscope in the United Kingdom, make sure the power cord meets the following safety instructions.

NOTE: This lead/appliance must only be wired by competent persons

 **WARNING: THIS APPLIANCE MUST BE EARTHED**

IMPORTANT: The wires in this lead are coloured in accordance with the following code:

Green/ Yellow:	Earth
Blue:	Neutral
Brown:	Live (Phase)



As the colours of the wires in main leads may not correspond with the coloured marking identified in your plug/appliance, proceed as follows:

The wire which is coloured Green & Yellow must be connected to the Earth terminal marked with either the letter E, the earth symbol  or coloured Green/Green & Yellow.

The wire which is coloured Blue must be connected to the terminal which is marked with the letter N or coloured Blue or Black.

The wire which is coloured Brown must be connected to the terminal marked with the letter L or P or coloured Brown or Red.

If in doubt, consult the instructions provided with the equipment or contact the supplier.

This cable/appliance should be protected by a suitably rated and approved HBC mains fuse: refer to the rating information on the equipment and/or user instructions for details. As a guide, a cable of 0.75mm<sup>2</sup> should be protected by a 3A or 5A fuse. Larger conductors would normally require 13A types, depending on the connection method used.

Any exposed wiring from a cable, plug or connection that is engaged in a live socket is extremely hazardous. If a cable or plug is deemed hazardous, turn off the mains power and remove the cable, any fuses and fuse assemblies. All hazardous wiring must be immediately destroyed and replaced in accordance to the above standard.

# GETTING STARTED

This chapter describes the MSO-2000E/2000EA in a nutshell, including its main features and front / rear panel. After going through the overview, follow the Set Up section to properly set up the device for first time use. The Set Up section also includes an introduction on how to use this manual effectively.



<b>MSO-2000E/2000EA Series Overview .....</b>	<b>14</b>
Integrated instruments and series lineup .....	14
Main Features .....	15
Accessories.....	16
<b>Appearance.....</b>	<b>18</b>
MSO-2000E/2000EA 4-channel models Front Panel ...	18
MSO-2000E/2000EA 2-channel models Front Panel ...	19
MSO-2000E Rear Panel .....	26
MSO-2000EA Rear Panel.....	26
Display .....	28
<b>Set Up .....</b>	<b>31</b>
Tilt Stand.....	31
Power Up .....	32
First Time Use.....	33
How to Use This Manual.....	36

Built-in Help ..... 41

## MSO-2000E/2000EA Series Overview

### Integrated instruments and series lineup

The MSO-2000E and MSO-2000EA have different hardware implemented instruments:

Model name	Logic Analyzer (16 channels)	Arbitrary Wave Generator (2 channels)
MSO-2000E	✓	✗
MSO-2000EA	✓	✓

The MSO-2000E/2000EA series consists of 6 models, divided into 2-channel and 4-channel versions. Note that throughout the user manual, the term “MSO-2000E/2000EA” refers to all models of the series, unless stated otherwise.

Model name	Frequency bandwidth	Input channels	Max. Real-time Sampling Rate
MSO-2072E / 2072EA	70MHz	2	1GSa/s
MSO-2074E / 2074EA	70MHz	4	1GSa/s
MSO-2102E / 2102EA	100MHz	2	1GSa/s
MSO-2104E / 2104EA	100MHz	4	1GSa/s
MSO-2202E / 2202EA	200MHz	2	1GSa/s
MSO-2204E / 2204EA	200MHz	4	1GSa/s

## Main Features

---

- Features
- 8 inch, 800 x 480, WVGA TFT display.
  - Available from 70MHz to 200MHz.
  - Real-time sampling rate of 1GSa/s (2 channel models), 1GSa/s max. (4 channel models).
  - Deep memory: 10M points record length.
  - Waveform capture rate of 120,000 waveforms per second.
  - Vertical sensitivity: 1mV/div~10V/div.
  - Segmented Memory: Optimizes the acquisition memory to selectively capture only the important signal details. Up to 29,000 successive waveform segments can be captured with a time-tag resolution of 4ns.
  - Waveform Search: Allows the scope to search for a number of different signal events.
  - Logic Analyzer: Can be used to measure discrete inputs or measure values on parallel or serial buses.
  - Arbitrary Wave generator (MSO-2000EA only): Full-function dual channel arbitrary waveform generator.
  - Powerful embedded applications such as: Data Logging, Digital Voltmeter, Go-No Go, Mask, Digital filter, etc ...
  - On-screen Help.
  - 32 MB internal flash disk.
-

- Interface
- USB host port: front panel, for storage devices.
  - USB device port: rear panel, for remote control or printing.
  - Ethernet port as standard.
  - Probe compensation output with selectable output frequency (1kHz ~ 200kHz).
  - Calibration output.

## Accessories

Standard Accessories	Part number	Description
	N/A	Quick Start Guide
	N/A region dependent	Power cord
	GTP-070B-4, for MSO-2072E/2072EA MSO-2074E/2074EA	Passive probe; 70 MHz
	GTP-100B-4, for MSO-2102E/2102EA MSO-2104E/2104EA	Passive probe; 100 MHz
	GTP-200B-4, for MSO-2202E/2202EA MSO-2204E/2204EA	Passive probe; 200 MHz
	GTL-16E	16-channel Logic Analyzer probe

Standard Apps	Name	Description
	Go-NoGo	Go-NoGo testing app.
	DataLog	Waveform or image data logging app.
	DVM	Digital Voltmeter app.
	Digital Filter	High or low pass digital filter for analog inputs.



---

	Mask	Creates shape templates for signal comparison.
	Remote Disk	Allows the scope to mount a network share drive.
Optional Accessories	Part number	Description
	Demo mode	Demonstration mode that is used with the GDB-03 demo board.
	GDB-03	Demo board.
Drivers, others		
	USB driver	LabVIEW driver

# Appearance

## MSO-2000E/2000EA 4-channel models Front Panel

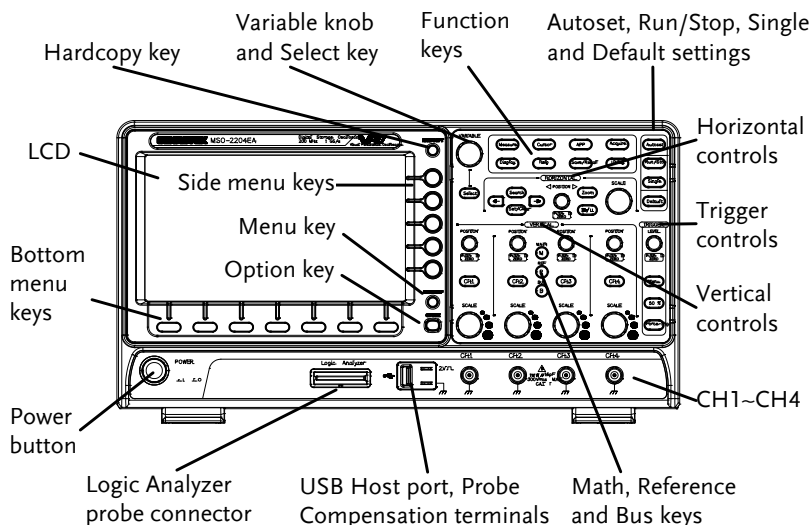

**MSO-2000E/2000EA 2-channel models Front Panel**

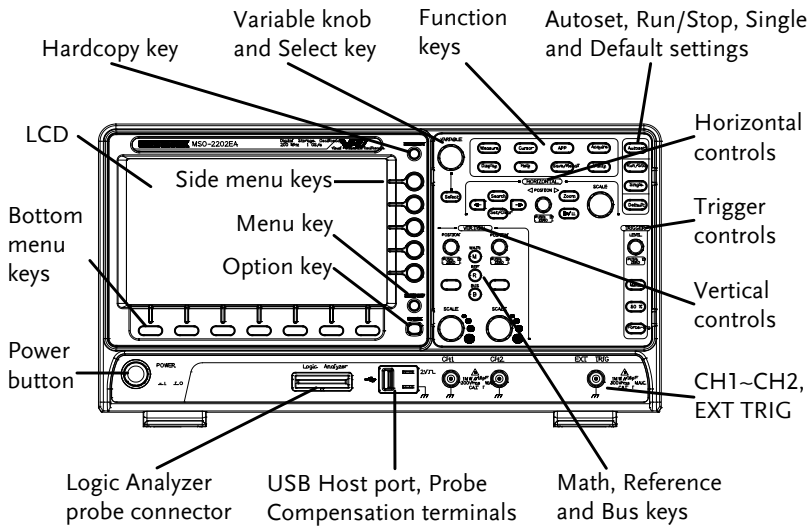

**LCD Display**      8" WVGA TFT color LCD. 800 x 480 resolution, wide angle view display.

**Menu Off Key**      **MENU OFF**      Use the Menu Off key to hide the onscreen menu system.



**Option Key**      **OPTION**      The Option key is used to access installed options.



**Menu Keys**

The side menu and bottom menu keys are used to make selections from the soft-menus on the LCD user interface.

To choose menu items, use the 7 Bottom menu keys located on the bottom of the display panel.

To select a variable or option from a menu, use the side menu keys on the side of the panel. See page 36 for details.

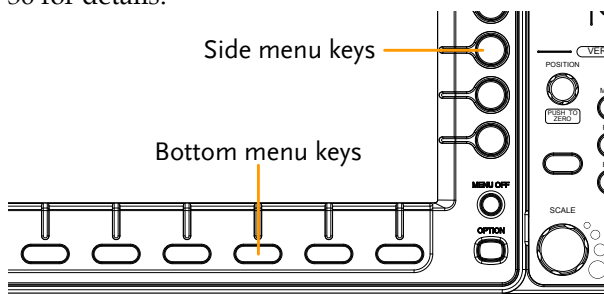

**Hardcopy Key**

**HARDCOPY**



The Hardcopy key is a quick-save or quick-print key, depending on its configuration. For more information see pages 317 (save) or 316 (print).

**Variable Knob and Select Key**



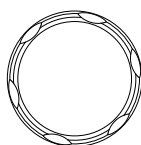



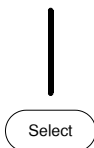

**VARIABLE**

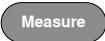

The Variable knob is used to increase/decrease values or to move between parameters.

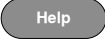

The Select key, when lit up, is used to make selections.

Function Keys		The Function keys are used to enter and configure different functions on the MSO-2000E/2000EA.
Measure		Configures and runs automatic measurements.
Cursor		Configures and runs cursor measurements.
APP		Configures and runs GW Instek applications.
Acquire		Configures the acquisition mode, including Segmented Memory acquisition.
Display		Configures the display settings.
Help		Shows the Help menu.
Save/Recall		Used to save and recall waveforms, images, panel settings.
Utility		Configures the Hardcopy key, display time, language, probe compensation and calibration. It also accesses the file utilities menu.
Autoset		Press the Autoset key to automatically set the trigger, horizontal scale and vertical scale.

Run/Stop Key  Press to Freeze (Stop) or continue (Run) signal acquisition (page 46). The run stop key is also used to run or stop Segmented Memory acquisition (page 95).

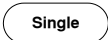
Single  Sets the acquisition mode to single triggering mode.





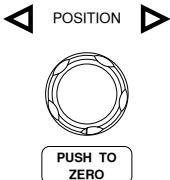



Default Setup  Resets the oscilloscope to the default settings.

Horizontal Controls  
The horizontal controls are used to change the position of the cursor, set the time base settings, zoom into the waveforms/traces and search for events.

Horizontal Position  The Position knob is used to position the waveforms/traces horizontally on the display screen. Pressing the knob will reset the position to zero.

SCALE  The Scale knob is used to change the horizontal scale (TIME/DIV).

Zoom  Press Zoom in combination with the horizontal Position knob.

Play/Pause		The Play/Pause key allows you to view each search event in succession – to effectively “play” through each search event. It is also used to play through a waveform/trace in zoom mode.
Search		The Search key accesses the search function menu to set the search type, source and threshold.
Search Arrows		Use the arrow keys to navigate the search events.
Set/Clear		Use the Set/Clear key to set or clear points of interest when using the search function.
Trigger Controls	The trigger controls are used to control the trigger level and options.	
Level Knob		Used to set the trigger level. Pressing the knob will reset the level to zero.
Trigger Menu Key		Used to bring up the trigger menu.
50% Key		Sets the trigger level to the half way point (50%).
Force - Trig		Press to force an immediate trigger of the waveform.

Vertical POSITION

POSITION



PUSH TO ZERO

Sets the vertical position of the waveform/trace. Push the knob to reset the vertical position to zero.

Channel Menu Key

CH1

Press the CH1~4 key to set and configure the corresponding channel.

(Vertical) SCALE Knob

SCALE

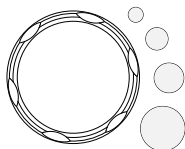

Sets the vertical scale of the channel (TIME/DIV).

External Trigger Input

EXT TRIG



Accepts external trigger signals (page 151). Only on 2 channel models.

Input impedance:  $1M\Omega$   
Voltage input:  $\pm 15V$  (peak), EXT trigger capacitance:  $16pF$ .

Math Key

MATH



Use the Math key to set and configure math functions.

Reference Key

REF



Press the Reference key to set or remove reference waveforms.

BUS Key

BUS



The Bus key is used for parallel and serial bus (UART, I<sup>2</sup>C, SPI, CAN, LIN) configuration.



Channel Inputs

**CH1**

Accepts input signals.  
Input impedance: 1MΩ.  
Capacitance: 16pF  
CAT I



USB Host Port

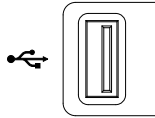

Type A, 1.1/2.0 compatible. Used for data transfer.

Ground Terminal

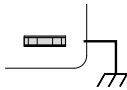

Accepts the DUT ground lead for common ground.

Probe Compensation Output

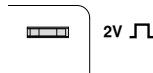

The probe compensation output is used for probe compensation. It also has an adjustable output frequency.

By default this port outputs a 2V<sub>pp</sub>, square wave signal at 1kHz for probe compensation.

Please see page 205 for details.

Power Switch



POWER

Used to turn the power on/off.

■ | ■ | ○ ■ | : ON

■ | ○ : OFF

Logic Analyzer



Logic Analyzer probe connector (see page 209)

### MSO-2000E Rear Panel

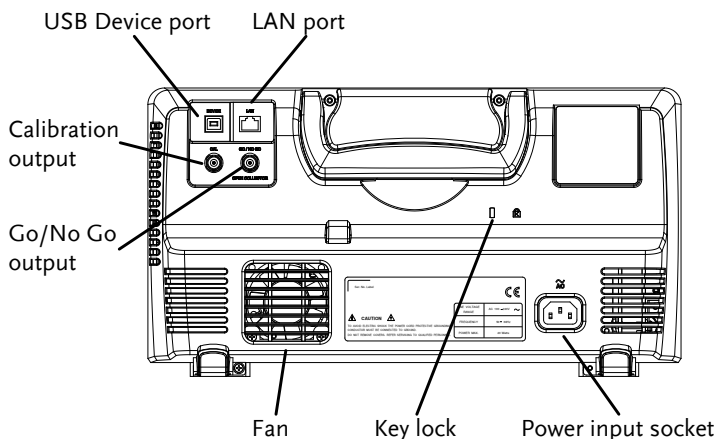

### MSO-2000EA Rear Panel

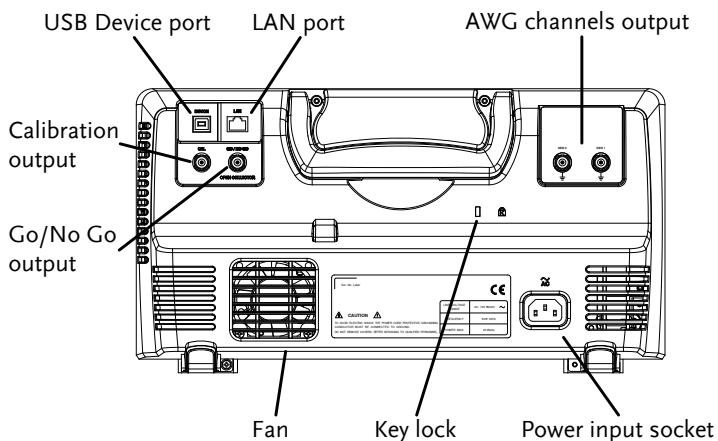

Calibration  
Output

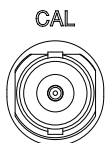

Outputs the signal for vertical scale accuracy calibration (page 332).

USB Device Port

**DEVICE**

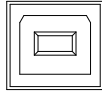

The USB Device port is used for remote control.

LAN (Ethernet) Port

**LAN**

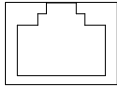

The LAN port is used for remote control over a network or when combined with the Remote Disk app, allows the scope to be mounted to a share disk.

Power Input Socket

**AC**

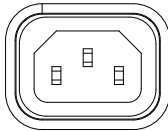

Power cord socket accepts AC mains, 100 ~ 240V, 50/60Hz.

For power up sequence, see page 32.

Security Slot



Kensington security slot compatible.

Go-No Go Output

**GO / NO GO**



Outputs Go-No Go test results (page 261) as a 500us pulse signal.

**OPEN COLLECTOR**

AWG Output

**GEN 1**





Output the GEN1 or GEN2 signal from the Arbitrary Wave Generator function, MSO-2000EA only (see page 226).

## Display

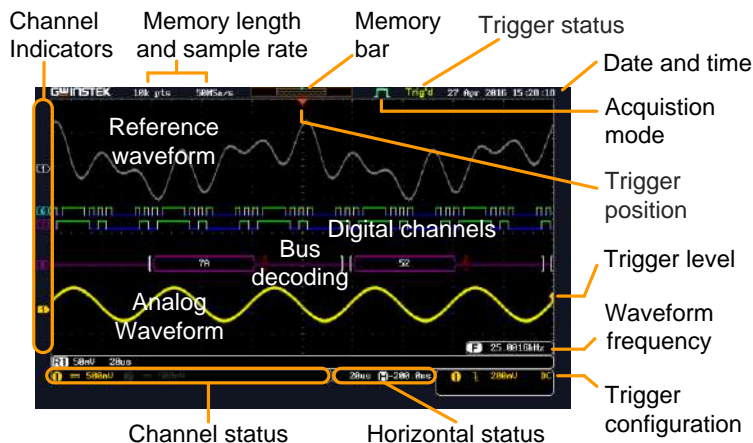
Below is a general description of the main display. As the display changes while activating the different functions of the MSO-2000E/2000EA, please refer to each function sub-chapters of this user manual for more details.



Analog Waveforms	Shows the analog input signal waveforms. Channel 1: Yellow      Channel 2: Blue Channel 3: Pink      Channel 4: Green
Bus decoding	Shows serial bus data decoding. The values are displayed in hex or binary.
Reference waveform	Reference waveform(s) can be displayed for reference, comparison or other operations.
Digital channels	Show the digital channels. Up to 16 channels can be displayed (Digital channel 0 to 15).
Channel Indicators	The channel indicators for each activated channels are located at the zero volt level of each signals. Any active channel is shown with a solid color. Example:  Analog channel indicator  Digital channel indicator

 Bus indicator(B)

 Reference waveform indicator

 Math indicator

Trigger Position Shows the position of the trigger.

Horizontal Status Shows the horizontal scale and position.

Date and Time 

Current date and time (page 204).

Trigger Level  Shows the trigger level on the graticule.

Memory Bar 



The ratio and the position of the displayed waveform compared to the internal memory (page 108).

Trigger Status

Trig'd	Triggered.
PrTrig	Pre-trigger.
Trig?	Not triggered, display not updated.
Stop	Trigger stopped. Also appears in Run/Stop (page 46).
Roll	Roll mode.
Auto	Auto trigger mode.

For trigger details, see page 151.

Acquisition Mode

	Normal mode
	Peak detect mode
	Average mode

For acquisition details, see page 86.

Signal Frequency  Shows the trigger source frequency.

 Indicates the frequency is less than 2Hz (lower frequency limit).

Trigger Configuration  Trigger source, slope, voltage and coupling.

Horizontal Status  Horizontal scale, horizontal position.

For trigger details, see page 151.

Channel Status  Channel 1, DC coupling, 2V/Div.

For channel details, see page 116.

## Set Up

### Tilt Stand

---

Tilt

To tilt, pull the legs forward, as shown below.

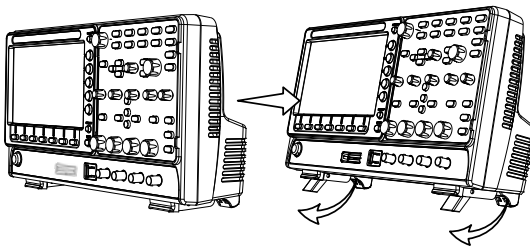

Stand

To stand the scope upright, push the legs back under the casing as shown below.

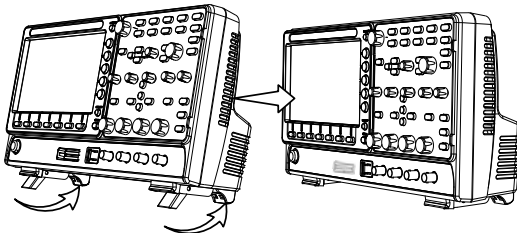

## Power Up

---

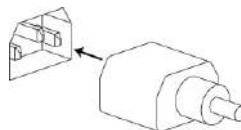

**Requirements**      The MSO-2000E/2000EA accepts line voltages of 100 ~ 240V at 50 or 60Hz.

**Step**                    1. Connect the power cord to the rear panel socket.

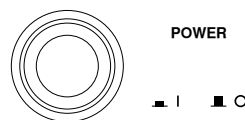

2. Press the POWER key. The display becomes active in ~ 30 seconds.



-  I: ON
-  O: OFF



The MSO-2000E/2000EA recovers the state right before the power is turned OFF. The default settings can be recovered by pressing the Default key on the front panel. For details, see page 301.



## First Time Use

---

**Background** This section describes how to connect, adjust the scale and compensate the probe. Before operating the MSO-2000E/2000EA in a new environment, run these steps to make sure the instrument performs at its full potential.

---

**1. Power On** Follow the procedures on the previous page.

---

**2. Firmware** Update to the latest firmware. Page 340

---

**3. Set the Date and Time** Set the date and time. Page 204.

---

**4. Reset System** Reset the system by recalling the factory settings. Press the *Default* key on the front panel. For details, see page 301. 

---

**5. Connect the probe** Connect the probe that you will use for measurements to the Channel 1 input and to the probe compensation output. This output provides by default a 2V peak to peak, 1kHz square wave for signal compensation.

Set the probe attenuation to x10 if the probe has adjustable attenuation.

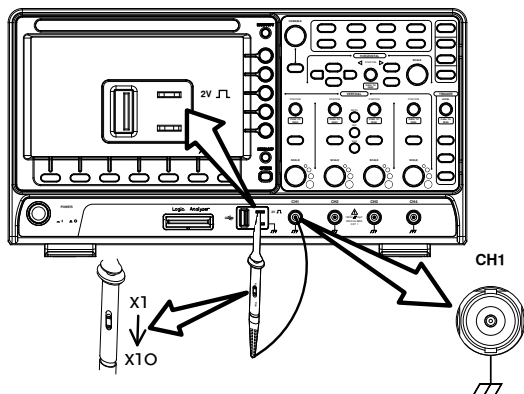

**6. Capture Signal (Autoset)**

Press the *Autoset* key. A square waveform appears on the center of the screen. For Autoset details, see page 44.

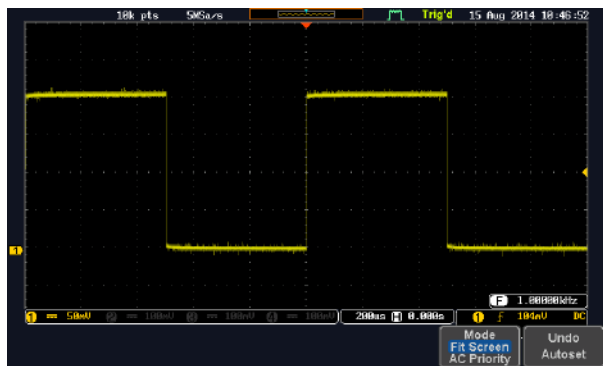

**7. Select Vector Waveform**

Press the *Display* key, and set the display to *Vector* on the bottom menu.

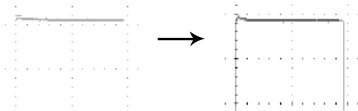
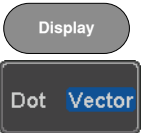

**8. Compensate the probe**

Turn the adjustment point on the probe to make the square waveform as flat as possible.

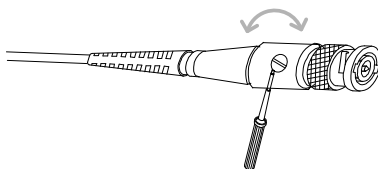
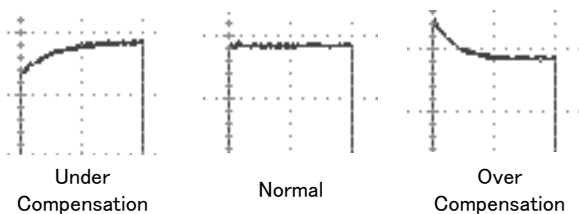

9. Start operations Continue with the other operations.

Measurement: page 42	Configuration: page 83
Using the Logic Analyzer: page 207.	Using the Arbitrary Wave Generator (MSO-2000EA only): page 223.
Applications: page 258	Save/Recall: page 282
File Utilities: page 308	Hardcopy key: page 315
Remote Control: page 319	Maintenance: page 330

## How to Use This Manual

**Background** This section describes the conventions used in this manual to operate the MSO-2000E/2000EA.

Throughout the manual any reference to pressing a menu key refers to the keys directly below or beside any menu icons or parameters.

When the user manual says to “toggle” a value or parameter, press the corresponding menu item. Pressing the item will toggle the value or parameter.

Active parameters are highlighted for each menu item. For example in the example below, Coupling is currently set to DC.

If a menu item can be toggled from one value or parameter to another, the available options will be visible, with the current option highlighted. In the example below the slope can be toggled from a rising slope to a falling slope or either slope.

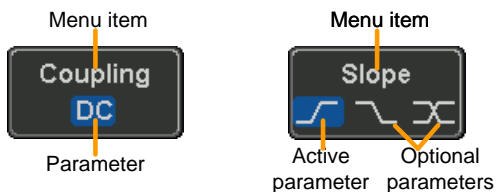

**Selecting a Menu Item, Parameter or Variable** When the user manual says to “select” a value from one of the side menu parameters, first press the corresponding menu key and use the Variable knob to either scroll through a parameter list or to increase or decrease a variable.

Example 1

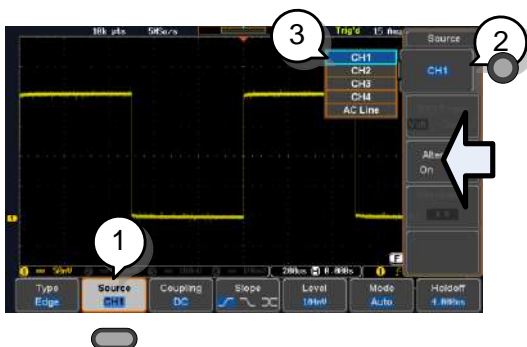

1. Press a bottom menu key to access the side menu.



2. Press a side menu key to either set a parameter or to access a sub menu.



3. If accessing a sub menu or setting a variable parameter, use the Variable knob to scroll through menu items or variables. Use the Select key to confirm and exit. The Select key is lit-up when such selection can be made.

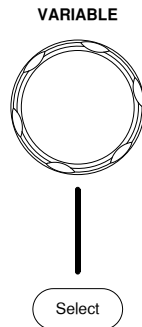

4. Press the same bottom menu key again to reduce the side menu.

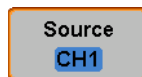

Example 2

For some variables, a circular arrow icon indicates that the variable for that menu key can be edited with the Variable knob.

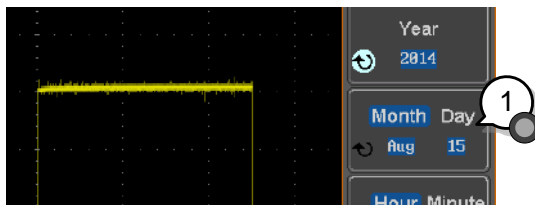

5. Press the desired menu key to select it. The circular arrow will become highlighted.



6. Use the Variable knob to edit the value.

Toggle a Menu Parameter



7. Press the bottom menu key to toggle the parameter.



Reduce Side Menu



8. To reduce the side menu, press the corresponding bottom menu that brought up the side menu.

For example: Press the *Source* soft-key to reduce the Source menu.

Reduce Lower Menu



9. Press the relevant function key again to reduce the bottom menu. For example: press the Trigger Menu key to reduce the trigger menu.

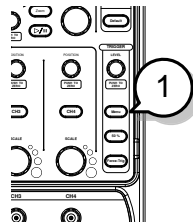

Remove All Menus



10. Press the *Menu Off* key to reduce the side menu, press again to reduce the bottom menu.

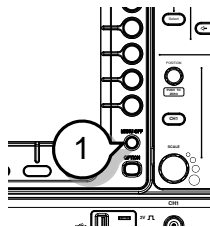

Remove On-Screen Messages

11. The *Menu Off* key can also be used to remove any on screen messages.

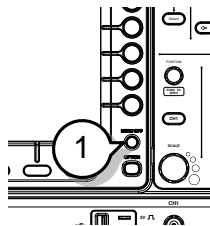



## Built-in Help

The Help key accesses a context sensitive help menu. The help menu contains information on how to use the front panel keys.

- Panel Operation
1. Press the *Help* key. The display changes to Help mode. 
  2. Use the *Variable* knob to scroll up and down through the Help contents. Press *Select* to view the help on the selected item.

Example: Help on the Display key

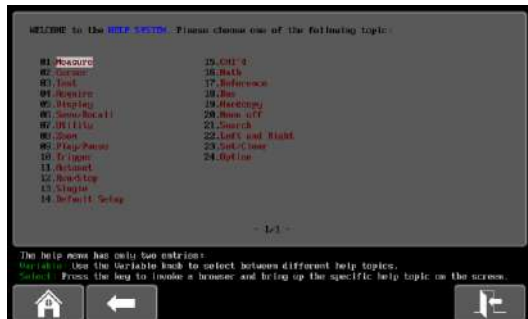

Home Key Press the *Home* key to return to the main help screen.



Go Back Press the *Back* key to go to the previous menu page.



Exit Press the *Help* key again or press the *Exit* key to exit the Help mode.

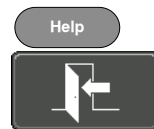

# M EASUREMENT

---

<b>Basic Measurement.....</b>	<b>43</b>
Channel Activation.....	43
Autoset .....	44
Run/Stop .....	46
Horizontal Position/Scale.....	47
Vertical Position/Scale .....	49
<b>Automatic Measurement.....</b>	<b>50</b>
Measurement Items.....	50
Add Measurement .....	54
Remove Measurement .....	57
Gated mode .....	57
Display All mode .....	58
High Low Function.....	59
Statistics .....	61
Reference Levels .....	63
<b>Cursor Measurement .....</b>	<b>65</b>
Use Horizontal Cursors.....	65
Use Vertical Cursors .....	69
<b>Math Operation .....</b>	<b>73</b>
Basic Math Overview & Operators.....	73
Addition/Subtraction/Multiplication/Division .....	73
FFT Overview & Window Functions.....	75
FFT Operation.....	76
Advanced Math Overview .....	78
Advanced Math Operation .....	79

## Basic Measurement

This section describes the basic operations required in capturing, viewing and measuring the input signal. For more detailed or more specific operations, see the following chapters.

- Advanced Configuration → from page 83
- Logic Analyzer → from page 207
- Arbitrary Wave Generator (MSO-2000EA only) → from page 223
- Applications → from page 258

Before operating the oscilloscope, please see the Getting Started chapter, page 12.

### Channel Activation

Activate Channel To activate an input channel, press a *channel* key.

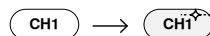

When activated, the channel key will light up. The corresponding channel menu will also appear.

Each channel is associated with the color shown beside each channel's vertical SCALE dial: CH1: yellow, CH2: blue, CH3: pink and CH4: green.

When a channel is activated, it is shown above the bottom menu system.



De-activate Channel To de-activate a channel, press the corresponding *channel* key again. If the channel menu is not open, press the *channel* key twice (the first press shows the Channel menu).

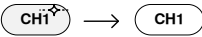

Default Setup To activate the default state, press *Default* (this will reset the system and recall the factory defaults, see page 301).



## Autoset

Background The Autoset function automatically configures the panel settings to position the input signal(s) to the best viewing condition. The MSO-2000E/2000EA automatically configures the following parameters:

- Horizontal scale
- Vertical scale
- Trigger source channel

There are two operating modes for the Autoset function: Fit Screen Mode and AC Priority Mode.

Fit Screen Mode will fit the waveform to the best scale, including any DC components (offset). AC priority mode will scale the waveform to the screen by removing any DC component.

- Panel Operation
1. Connect the input signal to the MSO-2000E/2000EA and press the *Autoset* key.
  2. The waveform appears in the center of the display.
- 

Before



After



- To undo Autoset, press *Undo Autoset* from the bottom menu.

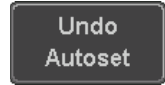

Change modes

- Choose between *Fit Screen Mode* and *AC Priority Mode* from the bottom menu.



- Press the *Autoset* key again to use Autoset in the new mode.



Fit Screen Mode

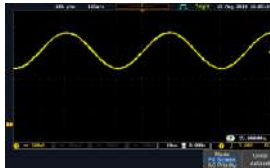

AC Priority



Limitation

Autoset does not work in the following situations:

- Input signal frequency is less than 20Hz
- Input signal amplitude is less than 10mV



The Autoset key does NOT automatically activate the channels to which input signals are connected.

## Run/Stop

**Background** By default, the waveform on the display is constantly updated (Run mode). Freezing the waveform by stopping signal acquisition (Stop mode) allows flexible observation and analysis. To enter Stop mode, two methods are available: pressing the Run/Stop key or using the Single Trigger mode.

Stop mode icon  When in Stop mode, the Stop icon appears at the top of the display.

Triggered icon  Stop icon appears at the top of the display.

**Freeze Waveform using the Run/Stop Key** Press the *Run/Stop* key once. The Run/Stop key turns red. The waveform and signal acquisition freezes.

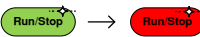
Stop: 

To unfreeze, press the *Run/Stop* key again. The Run/Stop key turns green again.

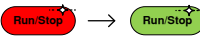
Run: 

**Freeze Waveform by Single Trigger Mode** Press the *Single* key to go into the Single Trigger mode. The Single key turns bright white.

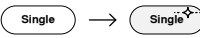

In the Single Trigger mode, the scope will be put into the pre-trigger mode until the scope encounters the next trigger point. After the scope has triggered, it will remain in Stop mode, until the *Single* key is pressed again or the *Run/Stop* key is pressed.

**Waveform Operation** The waveform can be moved or scaled in both Run and Stop mode, but in different manners. For details, see page 108 (Horizontal position/scale) and page 116 (Vertical position/scale).

## Horizontal Position/Scale

For more detailed configuration, see page 108.

**Set Horizontal Position**

The horizontal position knob moves the waveform left and right.

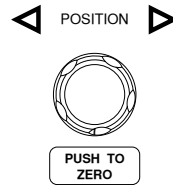

**Set Horizontal Position to 0**

Pressing the horizontal position knob will reset the horizontal position to 0.

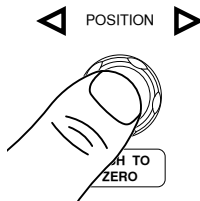

Alternatively, pressing the *Acquire* key and then pressing *Reset H Position to 0s* from the bottom menu will also reset the horizontal position.



As the waveform moves, the display bar on the top of the display indicates the portion of the waveform currently shown on the display and the position of the horizontal marker on the waveform.



**Position Indicator**

The horizontal position is shown at the bottom of the display grid to the right of the H icon.



**Select Horizontal Scale**

To select the timebase, turn the horizontal *SCALE* knob; left (slow) or right (fast).

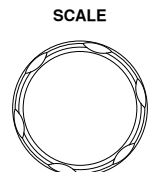

Range 1ns/div ~ 100s/div, 1-2-5 increments

The scale is displayed to the left of the H icon at the bottom of the screen.



Display bar The display bar indicates how much of the waveform is displayed on the screen at any given time. Changes to timebase will be reflected on the display bar.

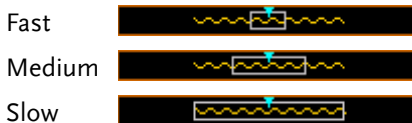

Stop mode In the Stop mode, the waveform size changes according to the scale.



The Sample rate changes according to the timebase and record length. See page 89.



## Vertical Position/Scale

For more detailed configuration, see page 116.

Set Vertical Position

To move the waveform up or down, turn the *vertical position knob* for each channel.



Push the *vertical position knob* to reset the position to 0.

As the waveform moves, the vertical position of the cursor appears on the display.

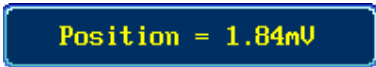
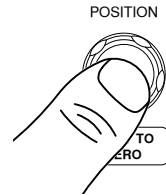

Run/Stop mode

The waveform can be moved vertically in both Run and Stop mode.

Select Vertical Scale

To change the vertical scale, turn the vertical *SCALE knob*; left (down) or right (up).

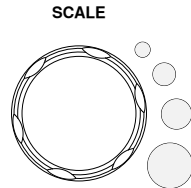

Range

1mV/div ~ 10V/div  
1-2-5 increments

The vertical scale indicator for each channel on the bottom of the display changes accordingly.







# Automatic Measurement

The automatic measurement function measures and updates major items for Voltage/Current, Time, and Delay type measurements.



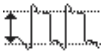
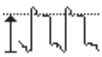
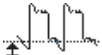
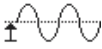
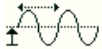

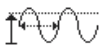
## Measurement Items

	V/I Measurements	Time Meas.	Delay Meas.			
Overview	Pk-Pk		Frequency		FRR	
	Max		Period		FRF	
	Min		RiseTime		FFR	
	Amplitude		FallTime		FFF	
	High		+Width		LRR	
	Low		-Width		LRF	
	Mean		Dutycycle		LFR	
	Cycle Mean		+Pulses		LFF	
	RMS		-Pulses		Phase	
	Cycle RMS		+Edges			
	Area		-Edges			
	Cycle Area		% Flicker			
	ROVShoot		Flicker Idx			
	FOVShoot					
	RPREShoot					
FPREShoot						

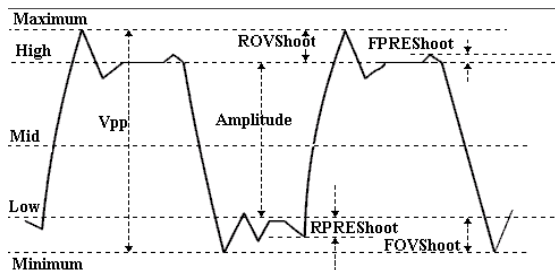





Voltage/Current Measurement	Pk-Pk (peak to peak)		Difference between positive and negative peak. (=max - min)
	Max		Positive peak.
	Min		Negative peak.













Amplitude		Difference between the global high value and the global low value, measured over the entire waveform or gated region. (=high – low)
High		Global high voltage. See page 59 for details.
Low		Global low voltage. See page 59 for details.
Mean		The arithmetic mean value is calculated for all data samples as specified by the Gating option.
Cycle Mean		The arithmetic mean value is calculated for all data samples within the first cycle found in the gated region.
RMS		The root mean square of all data samples specified by the Gating option.
Cycle RMS		The root mean square value is calculated for all data samples within the first cycle found in the gated region.
Area		Measures the positive area of the waveform and subtracts it from the negative area. The ground level determines the division between positive and negative areas.
Cycle Area		The Summation based on all data samples within the first cycle found in the gated region.







- ROVShoot  Rise overshoot
- FOVShoot  Fall overshoot
- RPRESShoot  Rise preshoot
- FPRESShoot  Fall preshoot

**Time Measurement**

- Frequency  Frequency of the waveform.
- Period  Waveform cycle time.  
(=1/Freq)
- RiseTime  The time required for the leading edge of the first pulse to rise from the low reference value to the high reference value.
- FallTime  The time required for the falling edge of the first pulse to fall from the high reference value to the low reference value.
- +Width  Positive pulse width.
- Width  Negative pulse width.

	Duty Cycle		Ratio of signal pulse compared with whole cycle. =100x (Pulse Width/Cycle)
	+Pulses		Measures the number of positive pulses.
	-Pulses		Measures the number of negative pulses.
	+Edges		Measures the number of positive edges.
	-Edges		Measures the number of negative edges.
	% Flicker		Ratio in percentage of the peak-to-peak value to the sum of peak values.
	Flicker Idx		Ratio of the area above the average to the total area during one cycle.
Delay Measurement	FRR		Time between: Source 1 first rising edge and Source 2 first rising edge.
	FRF		Time between: Source 1 first rising edge and Source 2 first falling edge.
	FFR		Time between: Source 1 first falling edge and Source 2 first rising edge.
	FFF		Time between: Source 1 first falling edge and Source 2 first falling edge.
	LRR		Time between: Source 1 first rising edge and Source 2 last rising edge.

LFR		Time between: Source 1 first rising edge and Source 2 last falling edge.
LRF		Time between: Source 1 first falling edge and Source 2 last rising edge.
LFF		Time between: Source 1 first falling edge and Source 2 last falling edge.
Phase		The phase difference of two signals, calculated in degrees.  $\frac{t1}{t2} \times 360^\circ$



Note

The built-in help system can be used to see detailed automatic measurement definitions.

## Add Measurement

The *Add Measurement* function allows you to add up to eight automatic measurement items on the bottom of the screen from any channel source.

Add  
Measurement  
Item

1. Press the *Measure* key.
2. Press *Add Measurement* from the bottom menu.

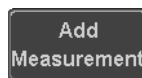

- Choose either a *V/I*, *Time* or *Delay* measurement from the side menu and choose the type of measurement you wish to add.

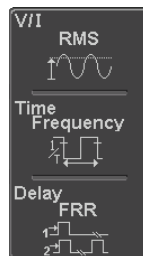

V/I (Voltage/ Current)	Pk-Pk, Max, Min, Amplitude, High, Low, Mean, Cycle Mean, RMS, Cycle RMS, Area, Cycle Area, ROVShoot, FOVShoot, RPREShoot, FPREShoot
Time	Frequency, Period, RiseTime, FallTime, +Width, -Width, Duty Cycle, +Pulses, -Pulses, +Edges, -Edges, %Flicker, FlickerIndex
Delay	FRR, FRF, FFR, FFF, LRR, LRF, LFR, LFF, Phase

- All of the chosen automatic measurements will be displayed in a window on the bottom of the screen. The channel number and channel color indicate the measurement source.  
For the analog inputs: yellow = CH1, blue = CH2, pink = CH3, green = CH4.



**Choose a Source** The channel source for measurement items can be set either before or when selecting a measurement item.

5. To set the source, press either the *Source1* or *Source2* key from the side menu and choose the source.



Range      Source1: CH1~CH4, Math, D0~D15  
                  Source2: CH1~CH4, Math

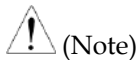

(Note)

Source 2 is only applicable to Delay measurements.

Only selected Time Frequency measurements can be applied to Digital channels D0~D15: Frequency, Period, +Width, -Width and Dutycycle.



## Remove Measurement

Individual measurements can be removed at any time using the Remove Measurement function.

---

Remove Measurement Item

1. Press the *Measure* key.
2. Press *Remove Measurement* from the bottom menu.
3. Press *Select Measurement* and select the item that you want to remove from the measurement list.

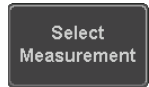
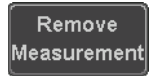

Remove All Items Press *Remove All* to remove all the measurement items.

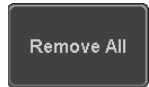

## Gated mode

Some automatic measurements can be limited to a “gated” area between cursors. Gating is useful for measuring a magnified waveform or when using a fast time base. The Gated mode has three configurations: Off (Full Record), Screen and Between Cursors.

---

Set Gating Mode 1. Press the *Measure* key.



2. Press *Gating* from the bottom menu.



3. Choose one of the gating modes from the side menu: *Off (full record)*, *Screen*, *Between Cursors*.

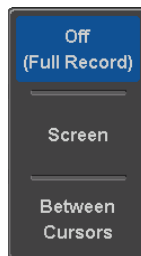

Cursors On  
Screen

If *Between Cursors* is selected, the cursor positions can be edited by using the cursor menu.

Page 65

### Display All mode

Display All mode shows and updates all items from Voltage and Time type measurements.

View  
Measurement  
Results

1. Press the *Measure* key.
2. Press *Display All* from the bottom menu.
3. Press *Source* from the side menu and choose a measurement source.

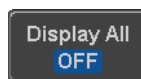

Range CH1~CH4, Math, D0~D15

4. The results of Voltage and Time type measurements appear on the display.



Remove  
Measurements

To remove the measurement results,  
press **OFF**.



Delay  
Measurements

Delay type measurements are not available in this mode as only one channel is used as the source. Use the individual measurement mode (page 54) instead.

Digital channels

Only Frequency, Period, +Width, -Width and Duty Cycle measurements are supported for the digital channels D0~D15.

## High Low Function

Background

The High-Low function is used to select the method for determining the value of the High-Low measurement values.

Auto

Automatically chooses the best high-low setting for each waveform when measuring.

**Histogram** Uses histograms to determine the high-low values. This mode ignores any pre-shoot or overshoot values. This mode is particularly useful for pulse-type waveforms

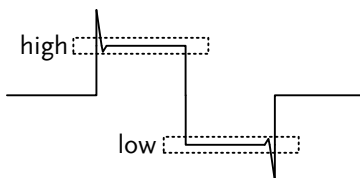

**Min-max** Sets the high-low values as the minimum or maximum measured values.

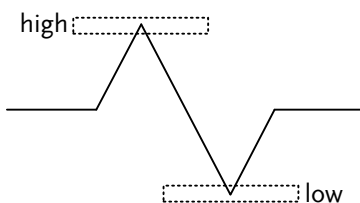

**Set High-Low**

1. Press the *Measure* key.



2. Press *High-Low* from the bottom menu.



3. Select the type of High-Low settings from the side menu.

High-Low Settings: Histogram, Min-Max, Auto

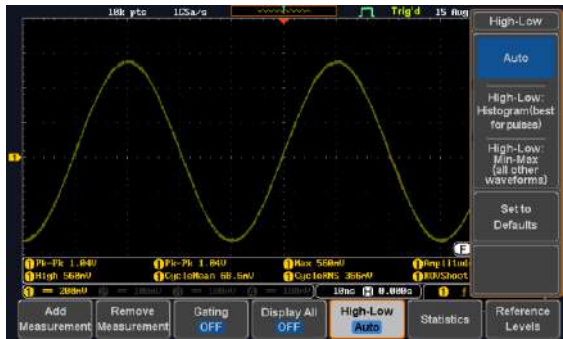

Restore Default High-Low Settings

To return to the default High-Low settings, press *Set to Defaults*.

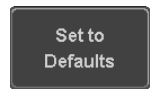

## Statistics



Background

The Statistics function can be used to view a number of statistics for the selected automatic measurements. The following information is displayed with the Statistics function:

Value	Currently measured value
Mean	The mean value is calculated from a number of automatic measurement results. The number of samples used to determine the mean can be user-defined.
Min	The minimum value observed from a series of measured results for the selected automatic measurement items.
Max	The maximum value observed from a series of measured results for the selected automatic measurement items.

Standard Deviation	The variance of the currently measured value from the mean. The standard deviation equals the squared root of the variance value. Measuring the standard deviation can, for example, determine the severity of jitter in a signal. The number of samples used to determine the standard deviation can be user-defined.
--------------------	--

Panel Operation

1. Press the *Measure* key. 
  
2. Select at least one automatic measurement. Page 54
  
3. Press *Statistics* from the bottom menu. 
  
4. Set the number of samples to be used in the mean and standard deviation calculations. 

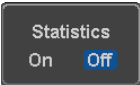
Samples: 2~1000
  
5. Press *Statistics* and turn Statistics on. 
  
6. The statistics for each automatic measurement will appear at the bottom of the display in a table.



Reset Statistics To reset the standard deviation calculations, press *Reset Statistics*.

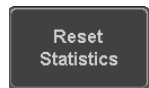

## Reference Levels

Background The reference level settings determine the measurement threshold levels for some measurements like the Rise Time measurement.

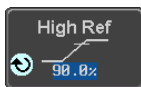

High Ref: Sets the high reference level.



Mid Ref: Sets the middle reference for the first and second waveforms.

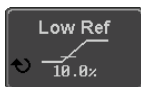

Low Ref: Sets the low reference level.

Panel Operation 1. Press the *Measure* key.

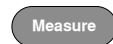

2. Press *Reference Levels* from the bottom menu.



3. Set the reference levels from the side menu.

Ensure the reference levels do not cross over.

High Ref	0.0% ~ 100%
Mid Ref	0.0% ~ 100%
	0.0% ~ 100%
Low Ref	0.0% ~ 100%

---

- Default Settings
4. Press *Set to Defaults* to set the reference levels back to the default settings.

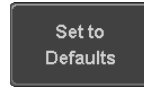



# Cursor Measurement

Horizontal or vertical cursors are used to show the position and values of waveform measurements and math operation results. These results cover voltage, time, frequency and other math operations. When the cursors (horizontal, vertical or both) are activated, they will be shown on the main display unless turned off.

## Use Horizontal Cursors

---

Panel Operation 1. Press the *Cursor* key once.

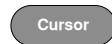

2. Press *H Cursor* from the bottom menu if it is not already selected.

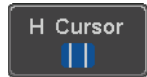

3. When the H Cursor is selected, repeatedly pressing the *H Cursor* key or the *Select* key will toggle which cursor is selected.



OR



Range	Description
∷	Left cursor (1) movable, right cursor position fixed
∷	Right cursor (2) movable, left cursor position fixed
	Left and right cursor (1+2) movable together

4. The cursor position information appears on the top left hand side of the screen

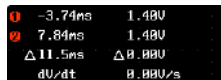

- Cursor 1 Hor. position, Voltage/Current
- Cursor 2 Hor. position, Voltage/Current
- Δ Delta (difference between cursors)
- dV/dt or dI/dt

5. Use the *Variable* knob to move the movable cursor(s) left or right.

VARIABLE

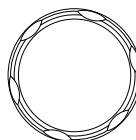

(Note)

The selected cursor(s) will move along the active waveform. To move along another waveform, select its corresponding channel and press the cursor key again to re-enter the cursor menu.

Select Units

6. To change the units of the horizontal position, press *H Unit*.

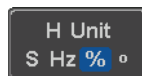

Units S, Hz, % (ratio), °(phase)

Phase or Ratio Reference

7. To set the 0% and 100% ratio or the 0° and 360° phase references for the current cursor positions, press *Set Cursor Positions As 100%*.



Example

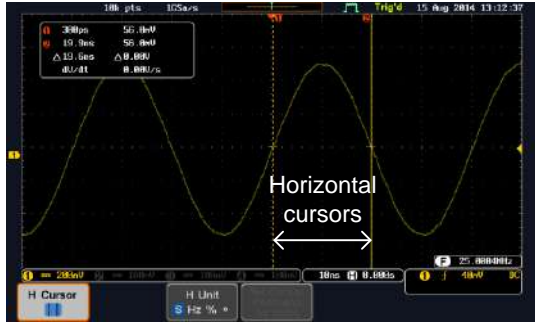

FFT

FFT cursors can use different units. For FFT details, see page 75.

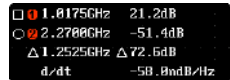





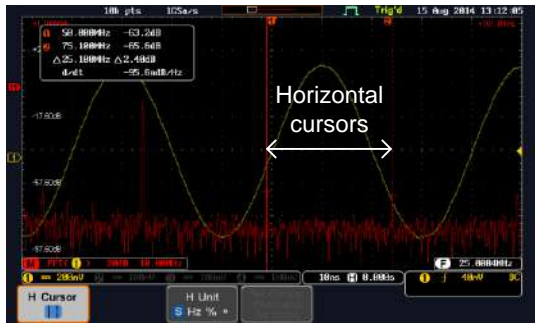

- Cursor ❶ Hor. position, dB/Voltage
- Cursor ❷ Hor. Position, dB/Voltage
- △ Delta (difference between cursors)  
dV/dt or d/dt

Example



XY Mode

XY mode cursors measure a number of X by Y measurements. See page 87.

 (X) Versus  (Y)	  $\Delta$			
	t:	-625us	625us	1.25ms
<b>Rectangular</b> 	x:	16.0U	17.6U	1.60U
	y:	1.76U	-1.44U	-3.20U
<b>Polar</b> 	r:	16.0U	17.6U	3.57U
	θ:	6.27°	-4.67°	-63.4°
<b>Product</b> 	x×y:	28.10U	-25.30U	-5.120U
<b>Ratio</b> y÷x:		110nU/U	-81.8nU/U	-2.00U/U

Cursor  Time, rectangular, polar coordinates, product, ratio.

Cursor  Time, rectangular, polar coordinates, product, ratio.

$\Delta$  Delta (difference between cursors)

Example

Horizontal  
cursors



## Use Vertical Cursors

Panel Operation/ Range 1. Press the *Cursor* key twice.



2. Press *V Cursor* from the bottom menu if it is not already selected.



3. When the *V Cursor* is selected, repeatedly pressing the *V Cursor* key or the *Select* key will toggle which vertical cursor is selected.



Range

- Upper cursor movable, lower cursor position fixed
- Lower cursor movable, upper cursor position fixed
- Upper and lower cursor movable together

4. The cursor position information appears on the top left hand side of the screen.

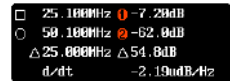

- Time: cursor 1, cursor 2
- Voltage/Current: cursor1, cursor2
- Delta (difference between cursors)  
dV/dt or dI/dt

5. Use the *Variable* knob to move the cursor(s) up or down.

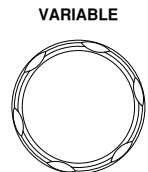

Select Units

- To change the units of the vertical position, press *V Unit*.

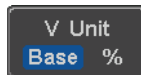

Units            Base (source wave units), % (ratio)

Base or Ratio Reference

- To set the 0% and 100% ratio references for the current cursor position, press *Set Cursor Positions As 100%*.



Example

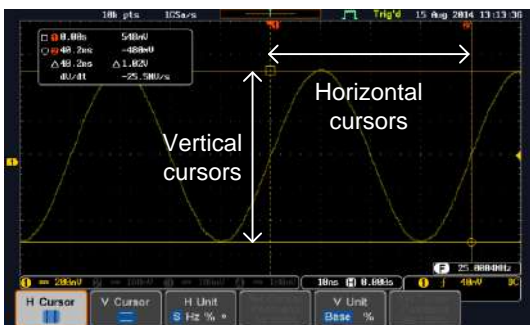

FFT

FFT has different content. For FFT details, see page 75.

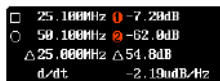

- ,             Frequency/Time: cursor1, cursor2
- 1**, **2**                            dB/V: cursor1, cursor2
- $\Delta$                                 Delta (difference between cursors)
- d/dt

Example

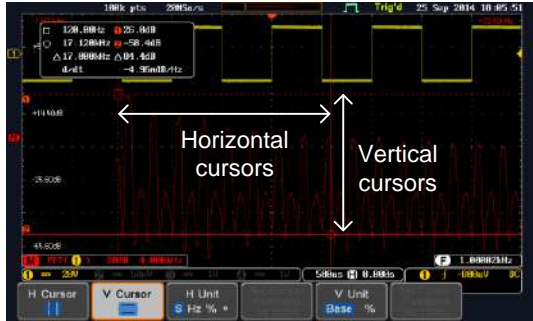

XY Mode

XY mode cursors measure a number of X by Y measurements. See page 87.

	t:	-625us	625us	1.25ms
<b>Rectangular</b> 	x:	18.4U	-14.4U	-32.8U
	y:	-1.44U	-1.68U	-248nV
<b>Polar</b> 	r:	18.4U	14.4U	32.8U
	θ:	-4.47°	-173°	-179°
<b>Product</b> 	x×y:	-26.40U	24.10U	7.870U
<b>Ratio</b> 	y÷x:	-78.2nU/U	116nU/U	7.31nU/U

- Cursor Rectangular, polar co-ordinates, product, ratio.
- Cursor Rectangular, polar co-ordinates, product, ratio.
- Delta (difference between cursors)

Example

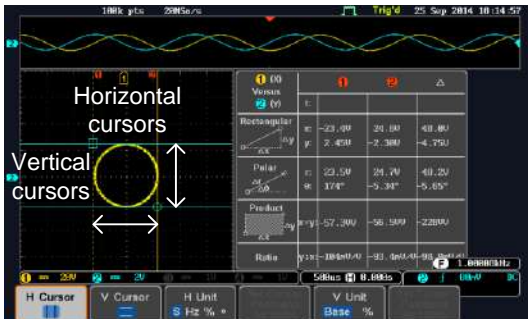



# Math Operation

## Basic Math Overview & Operators

Background	The Math function performs basic math functions (addition, subtraction, multiplication, division) on the input signals or the reference waveforms. The resultant waveform will be shown on the screen in real-time.
Addition (+)	Adds the amplitude of two signals. Source CH1~4, Ref1~4
Subtraction (-)	Extracts the amplitude difference between two signals. Source CH1~4, Ref1~4
Multiplication (×)	Multiplies the amplitude of two signals. Source CH1~4, Ref1~4
Division (÷)	Divides the amplitude of two signals. Source CH1~4, Ref1~4

## Addition/Subtraction/Multiplication/Division

Panel Operation 1. Press the *Math* key.

MATH



2. Press the *Math* key on the lower bezel.

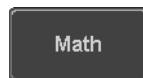

3. Select *Source 1* from the side menu



Range CH1~4, Ref1~4

4. Press *Operator* to choose the math operation.

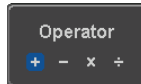

Range +, -, x, ÷

5. Select *Source 2* from the side menu.



Range CH1~4, Ref1~4

6. The math measurement result appears on the display. The vertical scale of the math waveform appears at the bottom of the screen.



From left: Math function, source1, operator, source2, Unit/div

Example

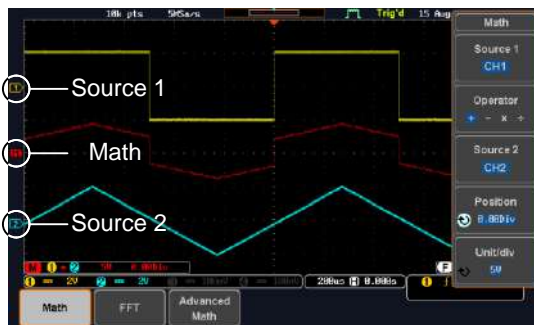

**Position and Unit** To move the math waveform vertically, press the *Position* key from the side menu and use the *Variable* knob to set the position.



Range -12.00 Div ~ +12.00 Div

To change the unit/div settings, press *Unit/div*, then use the *Variable* knob to change the unit/div.

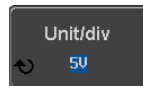

The units that are displayed depend on which operator has been selected, and whether the probe for the selected channel has been set to voltage or current.

Operator:	Unit/div:
Multiplication	VV, AA or W
Division	V/V, A/A
Addition/Subtraction	V or A

Turn Off Math To turn off the Math result from the display, press the *Math* key again.





## FFT Overview & Window Functions

**Background** The FFT function performs a Fast Fourier Transform on one of the input signals or the reference waveforms. The resultant spectrum will be shown on the screen in real-time. Four types of window function are available: Hanning, Hamming, Rectangular, and Blackman, as described below.

Hanning	Frequency resolution	Good
	Amplitude resolution	Not good
	Suitable for...	Frequency measurement on periodic waveforms

Hamming	Frequency resolution	Good
	Amplitude resolution	Not good
	Suitable for...	Frequency measurement on periodic waveforms
Rectangular	Frequency resolution	Very good
	Amplitude resolution	Bad
	Suitable for...	Single-shot phenomenon (this mode is the same as having no window at all)
Blackman	Frequency resolution	Bad
	Amplitude resolution	Very good
	Suitable for...	Amplitude measurement on periodic waveforms

## FFT Operation

- Panel Operation
- Press the *Math* key.
 
  - Press *FFT* from the bottom menu.
 
  - Select the *Source* from the side menu.
 

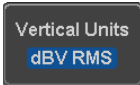
Range CH1~4, Ref~4
  - Press the *Vertical Units* key from the side menu to select the vertical units used.
 

Range Linear RMS, dBV RMS

5. Press the *Window* key from the side menu and select the window type.

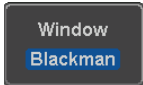

Range      Hanning, Hamming, Rectangular, and Blackman.

6. The FFT result represents the frequency-domain representation of a signal. Hence, the horizontal scale changes from time to frequency, and the vertical scale from voltage/current to dB/RMS.

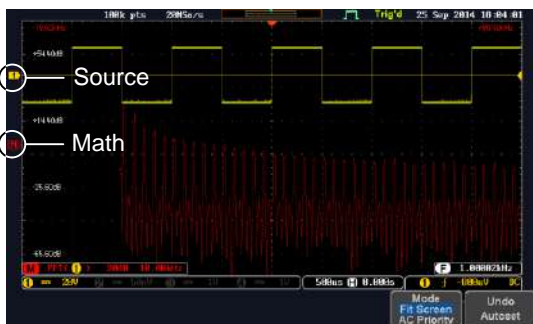

Position and Scale

To move the FFT waveform vertically, press *Vertical* until the *Div* parameter is highlighted and then use the Variable knob.



Range      -12.00 Div ~ +12.00 Div

To select the vertical scale of the FFT waveform, press *Vertical* until the *dB* or *voltage* parameters are highlighted and then use the Variable knob.

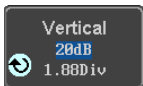

Range      2mV~1kV RMS (Linear RMS),  
1~20 dB (dB VRMS)

Horizontal Position and Scale

To move the FFT waveform horizontally, press *Horizontal* until the *Frequency* parameter is highlighted and then use the Variable knob.



Range            0Hz ~ half of the sampling frequency

To select the horizontal scale of the FFT waveform, press *Horizontal* repeatedly until the *Hz/div* parameter is highlighted and then use the Variable knob.

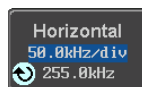

## Advanced Math Overview

Background

The advanced math function allows complex math expressions to be created based on the input sources, reference waveforms or even the automatic measurements available from the *Measure* menu (see page 50).

An overview of each of the major parameters that can be used in the advanced math function are shown below:

Expression

Displays the function expression as it is created.

Source

Selects the source signal.

Source            CH1~4, Ref1~4

Function

Adds a mathematical function to the expression.

Function            Intg, Diff, log, Ln, Exp, Sqrt, Abs, Rad, Deg, Sin, Cos, Tan, Asin, Acos, Atan

Variable

Adds a user-specified variable to the expression.

Source            CH1~4, Ref1~4

Operator	Adds an operator or parenthesis to the function expression.
Operator	+, -, *, /, (, ), !, <, >, <=, >=, ==, !=,    , &&
Figure	Adds a value to the expression.
Figure	Integers, floating point, or floating point with exponent values.
Measurement	Adds automatic measurements to the expression. Not all automatic measurements are supported.
Measurement	Pk-Pk, Max, Min, Amp, High, Low, Mean, CycleMean, RMS, CycleRMS, Area, CycleArea, ROVShoot, FOVShoot, Freq, Period, Rise, Fall, PosWidth, NegWidth, Dutycycle, FRR, FRF, FFR, FFF, LRR, LRF, LFR, LFF, Phase, RPRFShoot, FPREShoot, +Pulses, -Pulses, +Edges, -Edges

## Advanced Math Operation

Panel Operation 1. Press the *Math* key.



2. Press *Advanced Math* from the bottom menu.

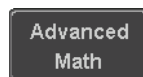

3. Press *Edit Expression*.

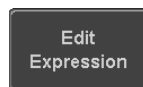

4. The Edit f(x) screen appears. CH1 + CH2 is shown in the expression box as an example at startup.



5. Press *Clear* to clear the expression entry area.

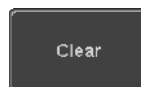

6. Use the *Variable* knob and the *Select* key to create an expression.

Use the *Variable* knob to highlight a source, function, variable, operator, figure or measurement in orange.

Press the *Select* key to make the selection.

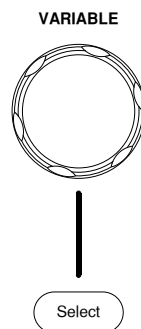

If a particular parameter is grayed out, it indicates that that particular parameter is not available at that time.

Back Space

7. To delete the last parameter press *Back Space*.

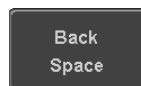

8. When the expression is complete, press *OK Accept*.

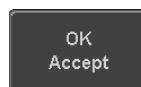



Example:  
CH1 + CH2

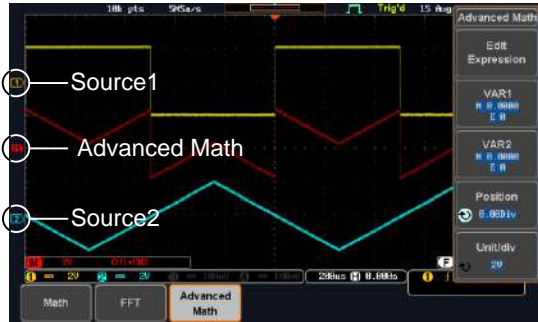

Set the VAR1 & VAR2

9. Press *VAR1* or *VAR2* to set VAR1/VAR2 if they were used in the expression created previously.



10. Press *Mantissa*.

Use the *Left* and *Right* arrow keys to select a digit and use the variable knob to set the value of the selected digit.



11. Press *Exponent*.

Use the Variable knob to set the exponent of the variable.

12. Press *Go Back* to finish editing VAR1 or VAR2.

Vertical Position and Scale

13. Press *Unit/div* and use the Variable knob to set the vertical scale of the math waveform.

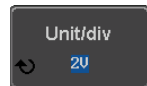

14. Press *Position* and use the Variable knob to set the vertical position of the math waveform on the display.



Clear Advanced  
Math

To clear the advanced math result  
from the display, press the *Math* key  
again.

MATH



# ADVANCED CONFIGURATION

---

Acquisition .....	86
Select Acquisition Mode.....	86
Show Waveform in XY Mode .....	87
Set the Record Length.....	89
Segmented Memory Acquisition .....	91
Segments Display .....	93
Set the Number of Segments .....	94
Run Segmented Memory.....	95
Navigate Segmented Memory .....	97
Play Through Each Segment.....	97
Measurement on Segments.....	98
Segment Info.....	102
Display.....	103
Display Waveform as Dots or Vectors .....	103
Set the Level of Persistence .....	103
Set the Intensity Level .....	104
Select Display Graticule .....	105
Freeze the Waveform (Run/Stop) .....	106
Turn Off Menu.....	107
Horizontal View .....	108
Move Waveform Position Horizontally .....	108
Select Horizontal Scale .....	109
Select Waveform Update Mode.....	110
Zoom Waveform Horizontally .....	111
Play/Pause .....	113
Vertical View (Channel).....	116
Move Waveform Position Vertically.....	116
Select Vertical Scale.....	117
Select Coupling Mode.....	117
Input Impedance .....	118
Invert Waveform Vertically .....	118

Limit Bandwidth .....	119
Expand by Ground/Center .....	120
Select Probe Type .....	121
Select Probe Attenuation Level .....	122
Set the Deskew .....	122
<b>Bus Key Configuration .....</b>	<b>124</b>
Bus Display .....	124
Serial Bus Overview .....	126
UART Serial Bus Configuration .....	128
I <sup>2</sup> C Serial Bus Interface .....	130
SPI Serial Bus Interface .....	132
CAN Serial Bus Interface .....	134
LIN Serial Bus Interface .....	136
Parallel Bus .....	138
Bus Decoding .....	140
Threshold configuration .....	140
Serial or Parallel Bus Event Tables .....	142
Event Tables Format .....	146
Adding a Label to a Bus .....	147
Using Cursors with the Serial or Parallel Bus .....	149
<b>Trigger .....</b>	<b>151</b>
Trigger Type Overview .....	151
Trigger: types and sources .....	153
Trigger Parameter Overview .....	154
Setup Holdoff Level .....	161
Setup Trigger Mode .....	162
Using the Edge Trigger .....	162
Using Advanced Delay Trigger .....	164
Using Pulse Width Trigger .....	166
Using Video Trigger .....	169
Pulse Runt trigger .....	170
Using Rise and Fall Trigger .....	172
Using the Timeout Trigger .....	173
Using the Bus Trigger .....	176
UART BUS Trigger Settings .....	176
I <sup>2</sup> C Bus Trigger Settings .....	177
SPI Bus Trigger Settings .....	181
CAN Bus Trigger .....	182
LIN Bus Trigger .....	185
Parallel Bus Trigger .....	187
Using the Logic Trigger .....	188
<b>Search .....</b>	<b>193</b>
Configuring Search Events .....	193

Copying Search Event To/From Trigger Events .....	195
Search Event Navigation .....	195
Save Search Marks.....	196
Setting/Clearing Single Search Events .....	197
FFT Peak .....	198
<b>System Settings and Miscellaneous Settings</b> .....	<b>202</b>
Select Menu Language.....	202
View System Information .....	203
Erase Memory.....	203
Set Date and Time.....	204
Probe Compensation Frequency .....	205
QR Code Reader Function .....	205

## Acquisition

The Acquisition process samples the analog input signals and converts them into digital format for internal processing.

### Select Acquisition Mode

---

Background	The acquisition mode determines how the samples are used to reconstruct a waveform.
Sample	This is the default acquisition mode. Every sample from each acquisition is used.
Peak detect	Only the minimum and maximum value pairs for each acquisition interval (bucket) are used. This mode is useful for catching abnormal glitches in the signal.
Average	Multiple acquired data is averaged. This mode is useful for drawing a noise-free waveform. To select the average number, use the Variable knob.  Average number: 2, 4, 8, 16, 32, 64, 128, 256

- Panel Operation
1. Press the *Acquire* key.
  2. To set the Acquisition mode, press *Mode* on the bottom menu.

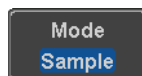

3. Select an acquisition mode from the side menu.
4. If *Average* was chosen, set the number of samples to be used for the average function.

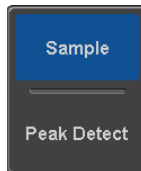

Mode	Sample, Peak Detect, Average
Average sample	2, 4, 8, 16, 32, 64, 128, 256

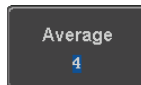

Example

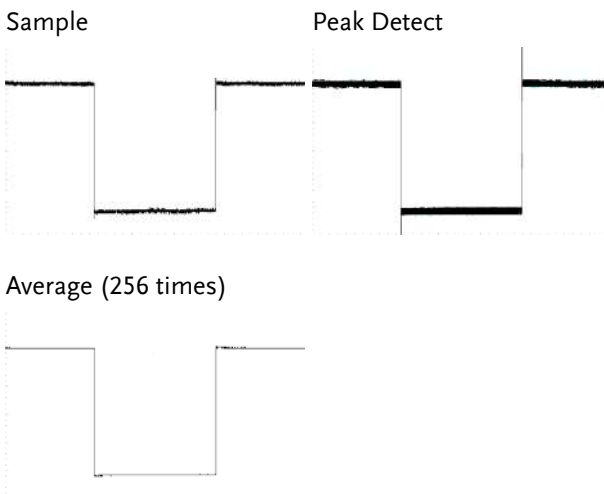

### Show Waveform in XY Mode

Background

The XY mode maps the input of channel 1 to the input of channel 2. In 4 channel models, the input of channel 3 can be mapped to the input of channel 4. This mode is useful for observing the phase relationship between waveforms.

Connection

1. Connect the signals to Channel 1 (X-axis) and Channel 2 (Y-axis) or Channel 3 (X2-axis) and Channel 4 (Y2-axis).

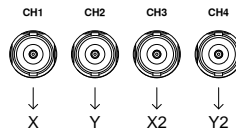

2. Make sure a channel pair is active (CH1&CH2 or CH3&CH4). Press the Channel key if necessary. A channel is active if the channel key is lit.

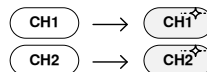

Panel Operation

3. Press the *Acquire* menu key.

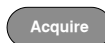

4. Press *XY* from the bottom menu.



5. Choose *Triggered XY* from the side menu.



X-Y mode is split into two windows. The top window shows the signals over the full time range. The bottom window shows XY mode.

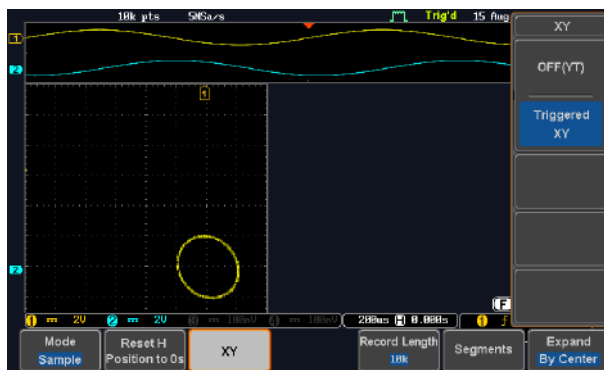



To move the XY waveform position, use the vertical position knob: Channel 1 knob moves the XY waveform horizontally and Channel 2 knob moves the XY waveform vertically. Similarly, the X2 and Y2 axis can be positioned using the channel 3 and channel 4 vertical position knobs.

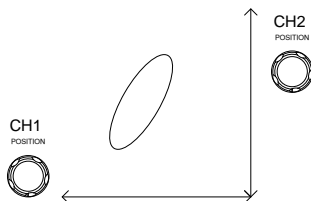

The horizontal position knob and horizontal Scale knob can still be used under the XY mode.

Turn Off XY Mode To turn off XY mode, choose *OFF (YT)* mode. OFF(YT)

Cursors and XY Mode Cursors can be used with XY mode. See the Cursor chapter for details. Page 65

### Set the Record Length

---

**Background** The number of samples that can be stored is set by the record length. Record length is important in an oscilloscope as it allows longer waveforms to be recorded.

The maximum record length for the MSO-2000E/2000EA depends on operating mode. The table below describes the record lengths that are available for each mode.

Limitations

Record Length	Normal	Zoom	FFT	FFT in Zoom Window
1k	✓	✗	✓	✗

10k	✓	✓	✓	✓
100k	✓	✓	✓	✓
1M	✓	✓	✓	✗
10M	✓	✓	✗	✗

Panel Operation 1. Press the *Acquire* key.



2. Press the *Record Length* key on the bottom menu and choose the record length.

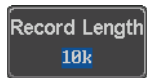

Record length 1000, 10k, 100k, 1M, 10M points



Note

The sampling rate may also be changed when the record length is changed.

## Segmented Memory Acquisition

The advanced segmented memory utility allows the scope memory to be divided into different segments. Each time the scope is triggered, it only acquires data for one segment of memory at a time. This allows you to optimize the scope memory to only perform signal acquisition during important signal events.

For example, for a signal with a number of pulses, normally the oscilloscope will acquire the signal until the acquisition memory of the scope is filled up and then it will re-arm the trigger and then capture again. This could result in a number of events not being captured or captured at a less-than-desired resolution (depending on the horizontal scale and sampling rate). However, the segmented memory function would effectively allow you to capture more of the signal than you would otherwise. The diagrams below illustrate this point.

Normal acquisition mode example:

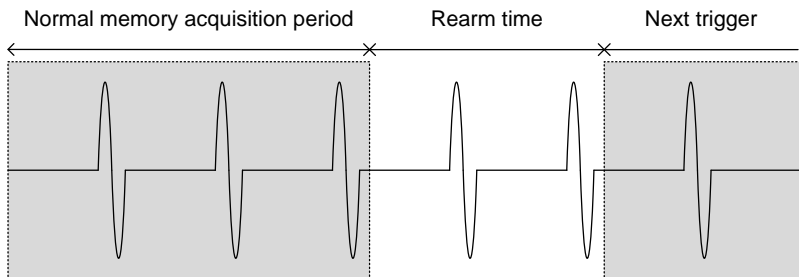

Segmented memory acquisition example:

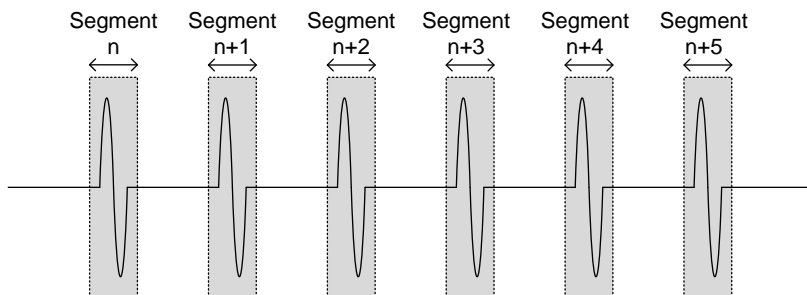

As shown above, the memory is divided into segments to increase the number of events that can be effectively captured with the same acquisition memory. Also notice that the scope doesn't need to rearm the trigger between each segment, this makes the segmented memory function especially useful for high speed signals. The time between each segment is also recorded so that accurate signal timing can also be measured.

The segmented memory function also supports automatic measurements for each segment or statistics for all the captured segments.

The advanced Segment Memory Utility is available for both analog and digital channels.

## Segments Display

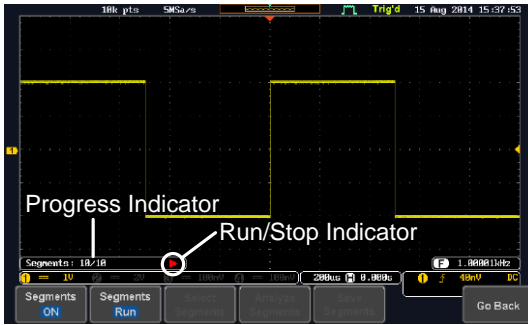

Progress Indicator

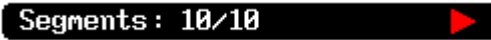

Indicates the number of segments that have to be captured relative to the set number of segments.

Run/Stop Indicator

- Stop: The segments have finished acquiring or have been stopped.
- Run: The scope is ready to acquire segments.

## Set the Number of Segments

**Note** Before the Segment function can be used, set the trigger settings as appropriate for the signal you wish to use. The number of segments that can be used depends wholly on the record length. See page 89 to set the record length.

Record length	Number of segments
1000 pt.	1 ~ 29000
10k pt.	1 ~ 2900
100k pt.	1 ~ 290
1M pt.	1 ~ 20
10M pt.	1 ~ 2

**Panel Operation** 1. Press the *Acquire* key.



2. Press *Segments* on the bottom menu.

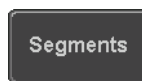

3. Press *Select Segments* and set the number of segments from the side menu.

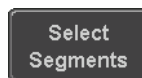

Num of Seg	1~29000 (record length dependant)
------------	-----------------------------------

Set to Maximum	Sets to the maximum number
----------------	----------------------------

Set to Minimum	Sets to 1 segment
----------------	-------------------

 **Note**

The Select Segments icon is only available when Segments = OFF or when Segments is in the STOP mode (see the section below).

## Run Segmented Memory

**Background** Before the Segmented Memory function can be used, set the trigger settings as appropriate for the signal you wish to use. See page 151 for configuring the trigger settings.

**Run Segments** 1. Toggle *Segments On* from the bottom menu.



**Note**

The first time Segmented memory is turned on the segments will automatically be run. Each segment will be automatically captured.

2. The scope will automatically start acquiring segments. The progress of the segmented memory capture is shown in the Progress Indicator.
3. The Run Indicator will be shown when in the Run mode and the Segments icon will also indicate that the function is in run mode.

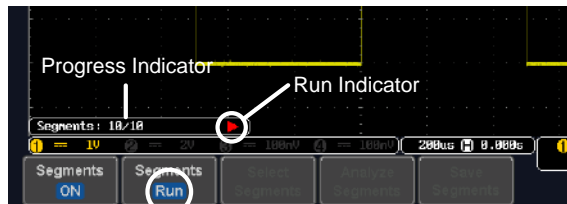

Segment (Run) icon

4. When the scope has finished acquiring segments, press *Segments Run* to toggle the mode to the *Segments Stop* mode.

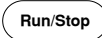

Alternatively, the *Run/Stop* key can be pressed. 

- The Stop Indicator will be shown when in the Stop mode.

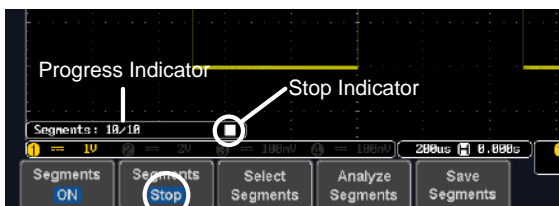

Segment (Stop) icon

The scope is now ready to navigate or analyze the acquired segments.

- Rerun Segmented Acquisition
- To rerun the segments, press the *Segments Stop* key to toggle the mode back to the *Segments Run* mode.

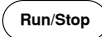

Alternatively, press the *Run/Stop* key again. 

- Repeat steps 3 and 4 in the section above when the segmented acquisition has completed.



## Navigate Segmented Memory

---

**Background** After the segmented memory acquisitions have been captured you can navigate through each segment one at a time.

---

**Operation** 1. Press *Select Segments* from the bottom menu. This key will be available in the Stop mode.

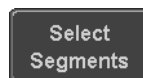

2. To navigate to the segment of interest, press *Current Seg* from the side menu and use the Variable knob to scroll to the segment of interest.



Alternatively, the *Set to Minimum* and *Set to Maximum* keys can be used to jump to the first and last segment respectively.

3. The position in time of the selected segment relative to the time of the first segment is shown in the *Segments Time* key.

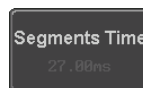

## Play Through Each Segment

---

**Background** When all the segments have been acquired, the play/pause key can be used to play back through each segment.

---

**Operation** 1. Make sure the scope is in *Segments Stop* mode. See page 95 for details.

2. Press the *Play/Pause* key to run through the acquired segments in numerical order.



- Press the Play/Pause key again to pause the playback.
- When the scope has played through to the last segment, pressing the Play/Pause key again will play through each segment again in reverse order.

## Measurement on Segments

---

**Background**      The Segmented memory function can be used in conjunction with the automatic measurements configured in the Measurement menu (see page 50). Please note that Digital channels measurements cannot be used in conjunction with the segmented memory.

---

<b>Modes</b>	<b>Segments Measure</b>	This function will either perform statistics calculations on the segments or tabulate a list of the measurement results for all the segments.
	<b>Segments Info</b>	Provides configuration information common for all the acquired memory segments.

---

**Segments Measure**      The Segments Measure function allows you to view automatic measurements for the segments in statistical bins or as a list displaying the result of each automatic measurement.

---

Statistics	This function will bin the measurement results of a single automatic measurement into a user-defined number of bins. This allows you to easily view statistics for a large number of segments. For example, the statistics function will display the number of results for each bin and the measurement range of each bin for the selected automatic measurement.
Measurement List	Puts all the measurement results for a segment in a list. All the currently selected automatic measurement results are listed. A maximum of 8 automatic measurements can be used with this function.

---



Note

To use automatic measurements with the segmented memory, automatic measurements must first be selected from the Measure menu before the segmented memory function is run. Note that Digital channels cannot use this function.

---

Setup

Press the *Measure* key and select any *single* source measurement from the *Add Measurement* menu.

See page 54 for details on how to add automatic measurements.

Operation

1. Press *Analyze Segments* from the Segments menu.

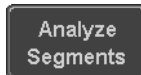

Note: This key will only be available in the Stop mode.

2. Press *Segments Measure*.



3. Select either the statistics or the measurement list from the side menu.



Statistics



List

4. The statics table or measurement list appears on the display.

Note that the more segments that you have, the longer it will take to calculate the statics or list the measurement results.

5. For statistic measurements, press *Plot Source* to choose which automatic measurement to use for the statistics calculations. The statistics for only one automatic measurement can be viewed at a time.



6. For the measurement list, press *Source* and select the source channel for measurement.



Range CH1 ~ CH4

**Statistics Results** This function will bin the measurement results of the selected automatic measurement into a user-defined number of bins.

**Setup** 7. To select the number of bins for the statistics, press *Divided by* and select the number of bins with the Variable knob.



Range 1~20 bins

8. Press *Select* and use the Variable knob to view the measurement results for each bin.



**Example:  
Statistics**

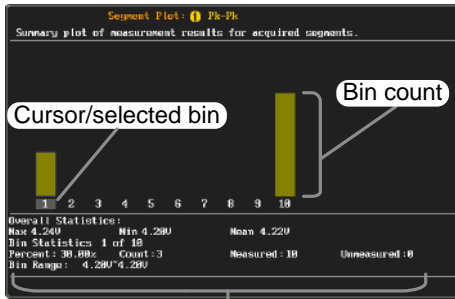

Statistics of currently selected bin

**Measurement List** Puts all the measurement results for a segment in a list.

**Setup** 9. Press *Select* and use the variable knob to scroll through each segment.

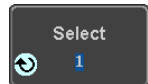

Example:  
Measurement  
List

Select  
cursor

Seg.	Fall PreShoot (s)	Rise PreShoot (s)	Plc-Plc (V)
1	0.00	0.57	4.24
2	0.00	0.57	4.20
3	0.00	0.57	4.24
4	0.00	0.57	4.24
5	0.00	0.57	4.20
6	0.00	0.57	4.24
7	0.00	0.57	4.20
8	0.00	0.57	4.24
9	0.00	0.57	4.24
10	0.00	0.57	4.24

## Segment Info

Operation

1. Press *Analyze Segments* from the bottom menu.

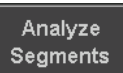

Note: This key will only be available in the Stop mode.

2. Press *Segments Info*.

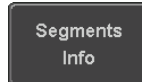

3. A table showing all general setting information for the segmented memory acquisitions is shown on the display.

Info: Sample rate, Record length,  
Horizontal, Vertical





## Display

The Display menu defines how the waveforms and parameters appear on the main LCD display.

### Display Waveform as Dots or Vectors

**Background** When the waveform is displayed on the screen, it can be displayed as dots or vectors.

**Panel Operation**

1. Press the *Display* menu key. 
2. Press *Dot / Vector* to toggle between Dot and Vector mode. 

<b>Range</b>	<b>Dots</b>	Only the sampled dots are displayed.
	<b>Vectors</b>	Both the sampled dots and the connecting line are displayed.



### Set the Level of Persistence

**Background** The persistence function allows the MSO-2000E/2000EA to mimic the trace of a traditional analog oscilloscope. A waveform trace can be configured to “persist” for a designated amount of time.

**Panel Operation** 1. Press the *Display* menu key. 

- To set the persistence time, press the *Persistence* menu button on the bottom bezel.



- Use the Variable knob to select a persistence time.



Time      16ms, 30ms, 60ms, 120ms, 240ms,  
0.5s, 1s, 2s, ~4s, Infinite, Off

Clear      To clear persistence, press *Clear Persistence*.

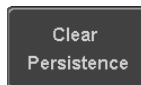

### Set the Intensity Level

Background      The intensity level of a signal can also be set to mimic the intensity of an analog oscilloscope by setting the digital intensity level.

Panel Operation      1. Press the *Display* menu key.



- Press *Intensity* from the bottom menu.

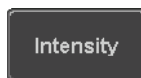

Waveform Intensity      3. To set the waveform intensity, press *Waveform Intensity* and edit the intensity.

Range      0~100%

Example      Waveform Intensity 50%      Waveform Intensity 100%

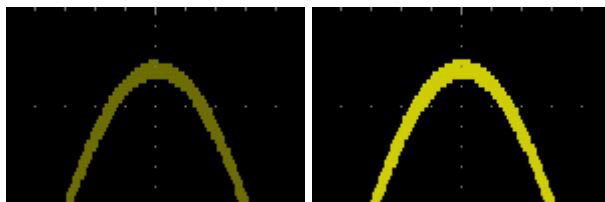



- Graticule Intensity 4. To set the graticule intensity, press *Graticule Intensity* from the side menu and edit the intensity value.

Range 10~100%

Example Graticule Intensity 100% Graticule Intensity 10%

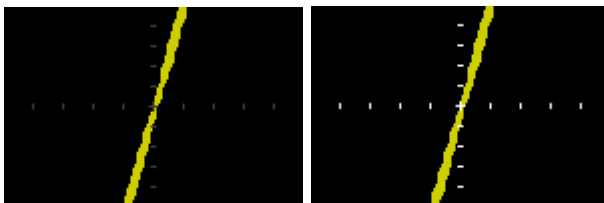

- Backlight Intensity 5. To set the LCD backlight intensity, press *Backlight Intensity* from the side menu and edit the intensity value.

Range 2~100%

- Backlight Auto-Dim 6. To automatically dim the backlight after a set duration, set *Backlight Auto-Dim* to On and then set *Time* to the appropriate time.

After the set amount of time with no panel activity, the screen will dim until a panel key is pressed again. This function will prolong the life of the LCD display.

Range 1~180 min

## Select Display Graticule

- Panel Operation 1. Press the *Display* menu key.

Display

2. Press *Graticule* from the bottom menu.

Graticule

- From the side menu choose the graticule display type.



*Full:* Shows the full grid; X and Y axis for each division.



*Grid:* Show the full grid without the X and Y axis.



*Cross Hair:* Shows only the center X and Y frame.



*Frame:* Shows only the outer frame.

### Freeze the Waveform (Run/Stop)

For more details about Run/Stop mode, see page 46.

#### Panel Operation

- Press the *Run/Stop* key. The *Run/Stop* key turns red and waveform acquisition is paused.

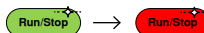

- The waveform and the trigger freezes. The trigger indicator on the top right of the display shows Stop.



- To unfreeze the waveform, press the *Run/Stop* key again. The *Run/Stop* key turns green again and acquisition resumes.

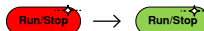

## Turn Off Menu

---

- Panel Operation
1. Press the *Menu Off* key below the side menu keys to reduce a menu. The menu key needs to be pressed each time to reduce one menu.

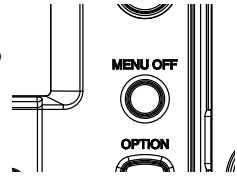

See page 36 for more information.

## Horizontal View

This section describes how to set the horizontal scale, position, and waveform display mode.

### Move Waveform Position Horizontally

**Panel Operation** The horizontal position knob moves the waveform left/right.

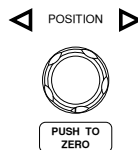

As the waveform moves, a position indicator on the top of the display indicates the horizontal position of the waveform in memory.



**Reset Horizontal Position** 1. To reset the horizontal position, press the Acquire key and then press *Reset H Position to 0s* from the bottom menu.

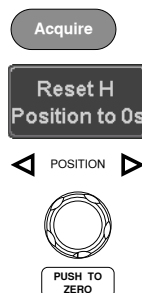

Alternatively, pushing the horizontal position knob will also reset the position to zero.

**Run Mode** In Run mode, the memory bar keeps its relative position in the memory since the entire memory is continuously captured and updated.

## Select Horizontal Scale

**Select Horizontal Scale** To select the timebase (time/div), turn the horizontal Scale knob; left (slow) or right (fast).



**Range** 1ns/div ~ 100s/div, 1-2-5 increment

The timebase indicator updates as the horizontal scale is adjusted.

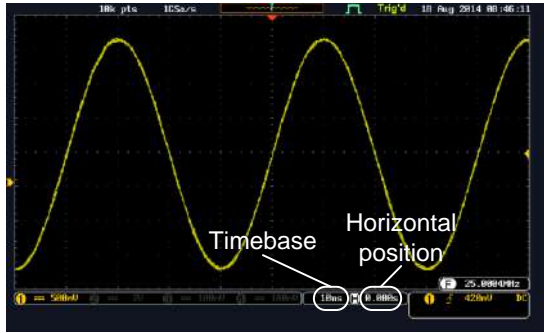

**Run Mode** In Run mode, the memory bar and waveform size keep their proportion. When the timebase becomes slower, roll mode is activated (if the trigger is set to Auto).

**Stop Mode** In Stop mode, the waveform size changes according to the scale.



## Select Waveform Update Mode

Background	The display update mode is switched automatically or manually according to the timebase and trigger.	
Normal	Updates the whole displayed waveform at once. Automatically selected when the timebase (sampling rate) is fast.	
	Timebase	≤50ms/div
	Trigger	all modes
Roll Mode	<b>Roll</b>	Updates and moves the waveform gradually from the right side of the display to the left. Automatically selected when the timebase (sampling rate) is slow.
	Timebase	≥100ms/div
	Trigger	all modes



Select Update Mode Manually

1. Press the Trigger *Menu* key.



2. Press *Mode* from the bottom menu and select *Auto (Untriggered Roll)* to let the equipment choose between Normal and Roll mode or *Normal* to force the update mode to Normal at all times.



## Zoom Waveform Horizontally

### Background

When in Zoom mode, the screen is split into 2 sections. The top of the display shows the full record length, while the bottom of the screen shows the normal view.

### Panel Operation

1. Press the *Zoom* key.



2. The Zoom mode screen appears.

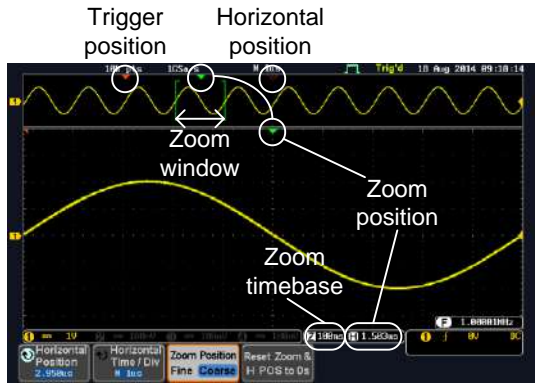

### Horizontal Navigation

To scroll the waveform left or right, press *Horizontal Position* and use the



*Variable Position knob.*

**VARIABLE**

The horizontal position will be shown on the *Horizontal Position* icon.

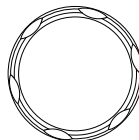

**Horizontal Scale** To change the horizontal scale, press *Horizontal Time/Div* and use the *Variable Position* knob.



The scale will be shown on the *Horizontal Time/Div* icon.

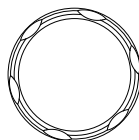

**Zoom** To increase the zoom range, use the horizontal *Scale* knob.

**SCALE**

The zoom time base (Z) at the bottom of the screen will change accordingly.

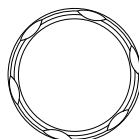

**Move the Zoom Window** Use the *Horizontal Position* knob to pan the zoom window horizontally.



To reset the zoom position, press the *Horizontal Position* knob.



The position of the zoom window, relative to the horizontal position is shown at the bottom of the screen next to the Zoom timebase.



**Scroll Sensitivity** To alter the scrolling sensitivity of the zoom window, press the *Zoom Position* key to toggle the scrolling sensitivity.

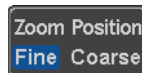



## Sensitivity Fine, Coarse

---

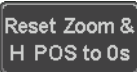
Reset the Zoom & Horizontal Position	To reset both the zoom and horizontal position, press <i>Reset Zoom &amp; H POS</i> to 0s.	
--------------------------------------	--	---

---

Exit	To go back to the original view, press the <i>Zoom</i> key again.	
------	---	---

## Play/Pause

---

Background	The Play/Pause key can be used to play through signals in the Zoom mode.
------------	--

---

Note	If the Segmented memory function is turned on, pressing the play pause key will play through memory segments. See page 97 for more information.
------	---

---

Panel Operation	1. Press the <i>Play/Pause</i> menu key.	
-----------------	--	---

- The scope will go into the Zoom Play mode and begin to scroll through the acquisition (from left to right).

The full-record length waveform will be shown at the top and the zoomed section will be shown at the bottom. The Play/Pause indicator shows the play status.

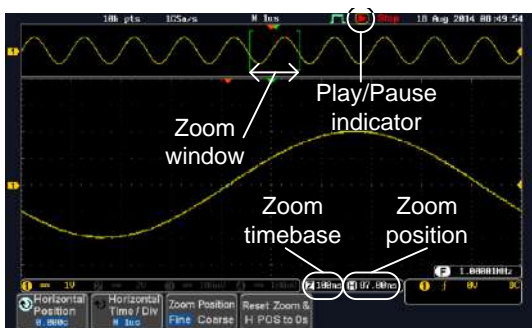

**Zoom**

To increase the zoom range, use the horizontal *Scale* knob.

The zoom time base (Z) at the bottom of the screen will change accordingly.

**SCALE**

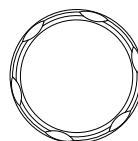

**Scroll Speed**

To alter the scrolling speed of the zoom window, press the *Zoom Position* key to toggle the scrolling speed.





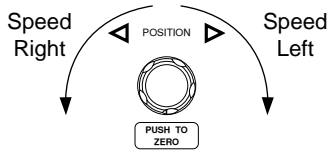

Sensitivity Fine, Coarse

Alternatively, use the horizontal position knob to control the scroll speed.

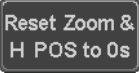
- Turning the Horizontal knob determines the speed and direction of the scrolling.



Reset the Zoom Position	To reset both the zoom position and horizontal position, press <i>Reset Zoom &amp; H POS to 0s</i> .	
Pause	Press the <i>Play/Pause</i> key to pause or resume playing the waveform.	
Reverse Direction	Press the <i>Play/Pause</i> key when at the end of the record length to play back through the waveform in reverse.	
Exit	To exit, press the <i>Zoom</i> key.	

## Vertical View (Channel)

This section describes how to set the vertical scale, position, and coupling mode.

### Move Waveform Position Vertically

Panel Operation 1. To move the waveform up or down, turn the *vertical position* knob for each channel.

POSITION



PUSH TO ZERO

2. As the waveform moves, the vertical position of the cursor appears at the bottom half of the display.

**Position = 0.00U**

View or Set the Vertical Position 3. Press a channel key. The vertical position is shown in the  *Position / Set to 0* soft key.

CH1

4. To change the position, press  *Position / Set to 0* to reset the vertical position or turn the *vertical position* knob to the desired level.

 Position /  
Set to 0  
1.000U

POSITION



PUSH TO ZERO

Run/Stop Mode The waveform can be moved vertically in both Run and Stop mode.

## Select Vertical Scale

**Panel Operation** To change the vertical scale, turn the vertical SCALE knob; left (down) or right (up).

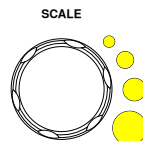

The vertical scale indicator on the bottom left of the display changes accordingly for the specific channel.

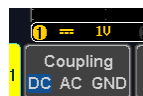

**Range** 1mV/div ~ 10V/div. 1-2-5 increments

**Stop Mode** In Stop mode, the vertical scale setting can be changed.

## Select Coupling Mode

**Panel Operation** 1. Press a *channel* key.



2. Press *Coupling* repeatedly to toggle the coupling mode for the chosen channel.



**Range**

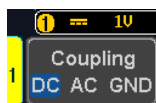

DC coupling mode. The whole portion (AC and DC) of the signal appears on the display.

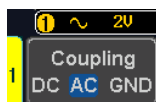

AC coupling mode. Only the AC portion of the signal appears on the display. This mode is useful for observing AC waveforms mixed with DC signals.

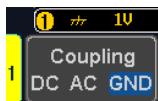

Ground coupling mode. The display shows only the zero voltage level as a horizontal line.

Example

Observing the AC portion of the waveform using AC coupling

DC coupling

AC coupling

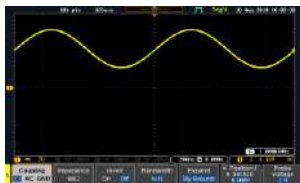

## Input Impedance

Background

The input impedance of the MSO-2000E/2000EA is fixed at  $1M\Omega$ . The impedance is displayed in the channel menu.

View Impedance 1. Press the *Channel* key.



2. The impedance is displayed in the bottom menu.

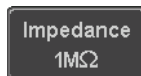

## Invert Waveform Vertically

Panel Operation 1. Press the *Channel* key.



2. Press *Invert* to toggle Invert On or Off.

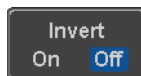

## Limit Bandwidth

**Background**      Bandwidth limitation puts the input signal into a selected bandwidth filter.

This function is useful for cutting out high frequency noise to see a clear waveform shape.

The bandwidth filters available are dependent on the bandwidth of the oscilloscope model.

Also refer to the digital filter application, page 270.

- Panel Operation**
1. Press the *Channel* key. CH1
  2. Press *Bandwidth* from the bottom menu. Bandwidth  
Full
  3. Choose a bandwidth\* from the side menu.  
\*Depending on the bandwidth of the oscilloscope.
- Range      70MHz models: Full, 20MHz  
                  100MHz models: Full, 20MHz  
                  200MHz models: Full, 20MHz,  
                  100MHz

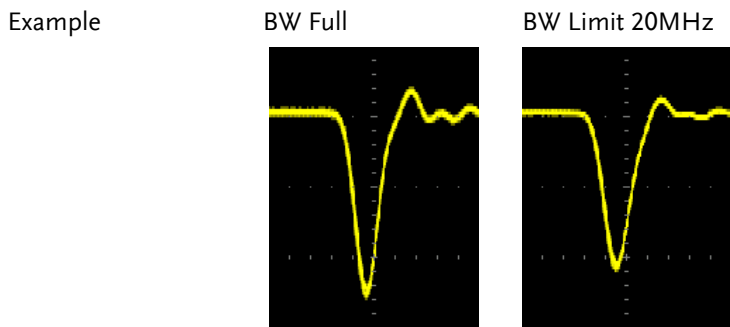

## Expand by Ground/Center

---

**Background** When the voltage scale is changed, the Expand function designates whether the signal expands from the center of the screen or from the signal ground level. Expand by center can be used to easily see if a signal has a voltage bias. Expand by ground is the default setting.

---

**Panel Operation** 1. Press a *channel* key.



2. Press *Expand* repeatedly to toggle between expand *By Ground* and *Center*.



Range By Ground, By Center

---

**Example** If the vertical scale is changed when the Expand function is set to ground, the signal will expand from the ground level\*. The ground level does not change when the vertical scale is changed.

If the vertical scale is changed when the Expand function is set to center, the signal will expand from the center of the screen. The ground level will suit to match the signal position.

\*Or from the upper or lower edge of the screen if the ground level is off-screen.



Expand by Ground

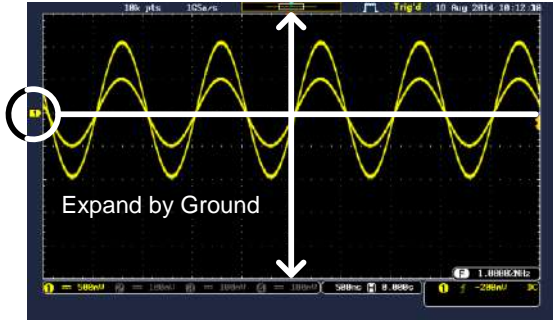

Expand by Center

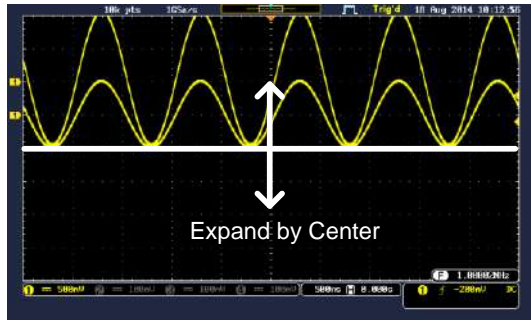

### Select Probe Type

**Background**      A signal probe can be set to voltage or current.

**Panel Operation**      1. Press the *Channel* key.



2. Press *Probe* from the bottom menu.



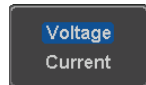

3. Press the *Voltage/Current* soft-key to toggle between voltage and current.



## Select Probe Attenuation Level

**Background** An oscilloscope probe has an attenuation switch to lower the original DUT signal level to the oscilloscope input range, if necessary. The probe attenuation selection adjusts the vertical scale so that the voltage level on the display reflects the real value on a DUT.

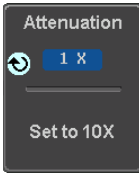

- Panel Operation**
1. Press the *Channel* key. 
  2. Press *Probe* from the bottom menu. 
  3. Press *Attenuation* on the side menu and use the Variable knob to set the attenuation. 

Alternatively, press *Set to 10X*.
- Range** 1mX ~1kX (1-2-5 step)

 **Note** The attenuation factor adds no influence on the real signal. It just changes the voltage/current scale on the display.

## Set the Deskew

**Background** The deskew function is used to compensate for the propagation delay between the oscilloscope and the probe.

- Panel Operation**
1. Press one of the *Channel* keys. 
  2. Press *Probe* from the bottom menu. 

3. Press *Deskew* on the side menu and use the Variable knob to set the deskew time.



Alternatively, press *Set to 0s* to reset the deskew time.

Range      -50ns~50ns, 10ps increments

4. Repeat the procedure for another channel if necessary.



## Bus Key Configuration

The Bus key is used to configure the Serial bus and parallel bus inputs. The bus inputs can be either analog or digital. The Bus menu also features event tables to track and save your bus data. The Bus key is used in conjunction with the Bus trigger (page 176) to decode serial or parallel bus signals.

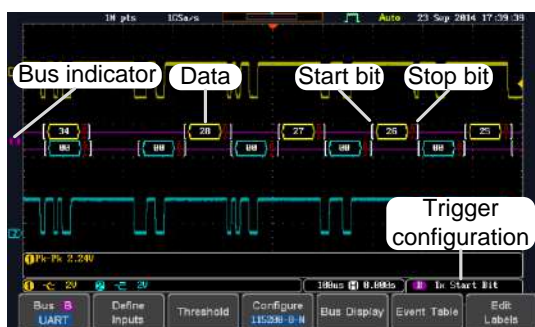
### Bus Display



- Start Bit/Start of Frame [ The Start bit is shown as an open bracket (Serial bus data only).
- Stop Bit/End of Frame ] The Stop bit is shown as a closed bracket (Serial bus data only).
- Data [ **F9** ] Data packets/frames/words can be shown in Hex or Binary. The color of the bus data indicates the type of data or the channel the data is coming from, depending on the bus type.
  - UART: Color of packet = Color of source channel.
  - I<sup>2</sup>C: Color packet = SDA source channel.
  - SPI: Color of packet = MOSI or MISO source channel.

	Parallel	All read words are shown in purple (no clock) or white (a clock is defined among the channels).
	CAN:	Purple = Error frame, Data length control (DLC), Overload. Yellow = Identifier. Cyan = Data. Orange = CRC. Red = Bit stuffing error
	LIN:	Purple = Break, Sync and Checksum errors, Wakeup Yellow = Identifier, Parity Cyan = Data Red = Error type
Error Indicator/ Missing Ack		If there is an error/missing acknowledgement in decoding the data, a red error indicator will be shown.
Bus Indicator		The Bus indicator shows the bus position. The active bus is shown with a solid color. The Variable knob can be used to horizontally position the Bus indicator when it is active.
	 Active bus (solid indicator)	 Activated bus (transparent indicator)
Trigger Configuration		Shows the bus trigger (B) and the <i>Trigger On</i> settings. Please see page 176.

 **ix Start Bit**

## Serial Bus Overview

The Serial Bus includes support for 5 common serial interfaces UART, I<sup>2</sup>C, SPI, Parallel, CAN and LIN. Each interface is fully configurable to accommodate variations in the basic protocols.

Each input can be displayed as binary, hexadecimal or ASCII. An event table can also be created to aid in debugging.

UART	<p>Universal Asynchronous Receiver Transmitter. The UART bus is able to accommodate a wide range of various common UART serial communications.</p> <p>The UART serial bus software is suitable for a number of RS-232 protocol variants.</p> <p>Inputs            Tx, Rx</p> <p>Threshold        Tx, Rx</p> <p>Configuration   Baud rate, Parity, Packets, End of packets, Input polarity</p> <p>Trigger On       Tx Start Bit, Rx Start Bit, Tx End of Packet, Rx End of Packet, Tx Data, Rx Data, Tx Parity Error, Rx Parity Error</p>
------	--

I <sup>2</sup> C	<p>Inter Integrated Circuit is a two line serial data interface with a serial data line (SDA) and serial clock line (SCLK). The R/W bit can be configured.</p> <p>Inputs            SCLK, SDA</p> <p>Threshold        SCLK, SDA</p> <p>Configuration   Addressing mode, Read/Write in address</p> <p>Trigger On       Start, Repeat Start, Stop, Missing Ack, Address, Data, Address/Data</p>
------------------	---

---

SPI	<p>The SPI (Serial Interface Peripheral) bus is fully configurable to accommodate the wide variety of SPI interfaces. This bus is only available on 4 channel models.</p> <p>Inputs            SCLK, SS, MOSI, MISO</p> <p>Threshold        SCLK, SS, MOSI, MISO</p> <p>Configuration   SCLK edge, SS logic level, Word size, Bit order</p> <p>Trigger On       SS Active, MOSI, MISO, MOSI&amp;MISO</p>
<hr/>	
CAN	<p>The CAN (Controller Area Network) bus is a 2-wire, message-based protocol.</p> <p>Inputs            CAN Input</p> <p>Threshold        CAN Input</p> <p>Configuration   Signal Type, Bit Rate</p> <p>Trigger On       Start of Frame, Type of Frame, Identifier, Data, Id &amp; Data, End of Frame, Missing Ack, Bit Stuffing Err.</p>
<hr/>	
LIN	<p>The LIN (Local Interconnect Network) bus is used to decode a wide range of common LIN configurations.</p> <p>Inputs            LIN Input</p> <p>Threshold        LIN Input</p> <p>Configuration   Bit Rate, LIN Standard, Include Parity Bits with Id</p> <p>Trigger On       Sync, Identifier, Data, Id &amp; Data, Wakeup Frame, Sleep Frame, Error</p>

## UART Serial Bus Configuration

The UART bus menu is designed to decode RS-232 and other common RS-232 variants such as RS-422, RS-485. The software configuration is also flexible enough to decode the many proprietary protocols based on RS-232.

### Background

Basic RS-232 protocol uses single-ended data transmissions. The signal voltage levels can be high ( $\pm 15V$ ) and employ active low signaling.

High speed variants of RS-232, such as RS-422 and RS-485 use differential signaling and commonly employ low voltage differential signals with active high signaling.

Universal Asynchronous Receiver/Transmitter (UART) or RS-232 driver/receiver ICs commonly used for embedded applications typically use active high signaling with standard IC signal levels.

### Operation

1. Connect each of the bus signals (*Tx*, *Rx*) to one of the oscilloscope's analog or digital channels. Connect the ground potential of the bus to one of the probes' ground clip if you are using the analog channels or to the ground connector of the Digital card if you are using the digital channels.

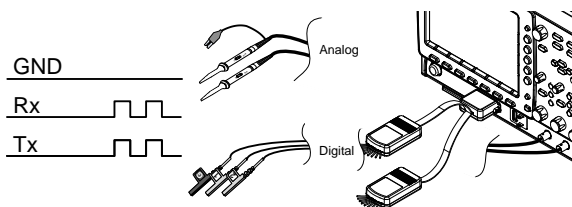

2. Press the *BUS* key.





- Press *Bus* from the bottom menu and choose the *UART* serial bus on the side menu.



- Press either *Analog Source* or *Digital Source* to choose whether the sources for the UART bus are analog or digital.



---

### Define Inputs

- Press *Define Inputs* from the bottom menu.

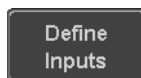

- From the side menu choose the *Tx Input* and the *Rx Input* source and the signal polarity.

Tx            OFF, CH1~CH4 or OFF, D0~D15 \*

Rx            OFF, CH1~CH4 or OFF, D0~D15 \*

Polarity    Normal (High = 0), Inverted (High = 1)

\*Depending on your choice at step 4 above.

---

### Configuration

The Configure key sets the baud rate, number of data bits and parity.

- Press *Configure* from the bottom menu.

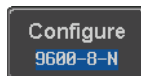

- From the side menu select the *Baud rate*, *Data bits*, *Parity*, *Packets* and *End of Packet bits*.

Baud Rate	50, 75, 110, 134, 150, 300, 600, 1200, 1800, 2000, 2400, 3600, 4800, 7200, 9600, 14400, 15200, 19200, 28800, 31250, 38400, 56000, 57600, 76800, 115200, 128000, 230400, 460800, 921600, 1382400, 1843200, 2764800
Data Bits	8 (fixed)
Parity	Odd, Even, None
Packets	On, Off
End of Packet (Hex)	00(NUL), 0A(LF), 0D(CR), 20(SP), FF

## I<sup>2</sup>C Serial Bus Interface

The I<sup>2</sup>C bus is a 2 wire interface with a serial data line (SDA) and serial clock line (SCLK). The I<sup>2</sup>C protocol supports 7 or 10 bit addressing and multiple masters. The scope will trigger on any of the following conditions: a start/stop condition, a restart, a missing acknowledge message, Address, Data or Address&Data frames. The I<sup>2</sup>C trigger can be configured for 7 or 10 bit addressing with the option to ignore the R/W bit as well as triggering on a data value or a specific address and direction (read or write or both).

---

- Panel operation
1. Connect each of the bus signals (*SCLK*, *SDA*) to one of the oscilloscope's analog or digital channels. Connect the ground potential to one of the probes' ground clip if you are using the analog channels or to the ground connector of the Digital card if you are using the digital channels.

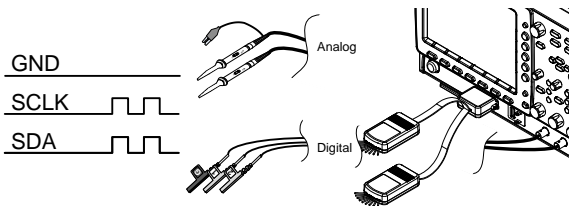

2. Press the *Bus* key.



3. Press *Bus* from the bottom menu and choose *I<sup>2</sup>C* from the side menu.

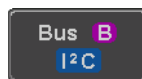

4. Press either *Analog Source* or *Digital Source* to choose whether the sources for the I<sup>2</sup>C bus are analog or digital.



Define Inputs

5. Press *Define Inputs* from the bottom menu.

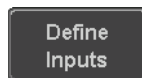

6. From the side menu choose the *SCLK* input and the *SDA* Input.

SCLK      CH1~CH4 or D0~D15 \*

SDA        CH1~CH4 or D0~D15 \*

\*Depending on your choice at step 4 above.

Include R/W in address

To configure whether you want the R/W bit to be included in the address, press *Include R/W in address* and set to Yes or No in the side menu.



R/W Bit    Yes, No

## SPI Serial Bus Interface

The serial peripheral interface (SPI) is a full duplex 4 wire synchronous serial interface. The 4 signals lines: Serial clock line (SCLK), slave select (SS), Master output/slave input (MOSI, or SIMO) and the Master input/slave output (MISO, or SOMI). The word size is configurable from 4 to 32 bits. The SPI triggers on the data pattern at the start of each framing period. Note: The SPI bus with analog source is only available for 4 channel models.

- Panel operation
1. Connect each of the bus signals (*SCLK*, *SS*, *MOSI*, *MISO*) to the oscilloscope's 4 analog channels or to one of the digital channels. Connect the ground potential to one of the probes' ground clip if you are using the analog channels or to the ground connector of the Digital card if you are using the digital channels.

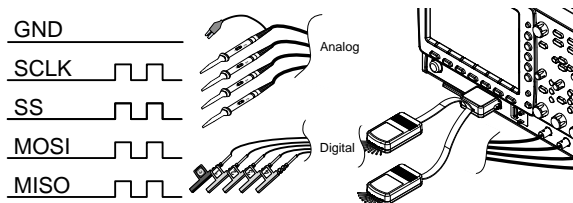

2. Press the *Bus* key.



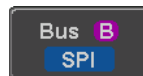

3. Press *Bus* from the bottom menu and choose the *SPI* serial bus.



4. Press either *Analog Source* or *Digital Source* to choose whether the sources for the SPI bus are analog or digital.

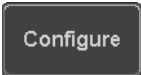

---

Define Inputs	<p>5. Press <i>Define Inputs</i> from the lower menu.</p> 
	<p>6. From the side menu choose the <i>SCLK</i>, <i>SS</i>, <i>MOSI</i> and <i>MISO</i> inputs.</p> <p><i>SCLK</i>      CH1~CH4 or D0~D15 *</p> <p><i>SS</i>        CH1~CH4 or D0~D15 *</p> <p><i>MOSI</i>     OFF, CH1~CH4 or OFF, D0~D15 *</p> <p><i>MISO</i>     OFF, CH1~CH4 or OFF, D0~D15 *</p> <p>*Depending on your choice at step 4 above.</p>
Configuration	<p>The <i>Configure</i> menu sets the data line logic level, <i>SCLK</i> edge polarity, word size and bit order.</p> <p>7. Press <i>Configure</i> from the bottom menu.</p> 
	<p>8. From the side menu select <i>SCLK</i> edge, <i>SS</i> logic level, word Size and Bit order.</p> <p><i>SCLK</i>      rising edge , falling edge </p> <p><i>SS</i>        Active High, Active Low</p> <p>Word Size 4 ~ 32 bits</p> <p>Bit Order MS First, LS First</p>

---

## CAN Serial Bus Interface

The controller area network (CAN) bus is a half duplex 2 wire synchronous serial interface. The CAN bus is a multi-master communication system that relies on arbitration to solve contention issues. The MSO-2000E supports both CAN 2.0A and 2.0B. The CAN bus uses two wires, CAN-High and CAN-Low. These wires are voltage inverted, and as such, the MSO-2000E/2000EA only needs one wire, CAN-High or CAN-Low for decoding.

- Panel operation
1. Connect the bus signal (*CAN Input*) to one of the oscilloscope's analog or digital channels. Connect the ground potential to one of the probes' ground clip if you are using the analog channels or to the ground connector of the Digital card if you are using the digital channels.

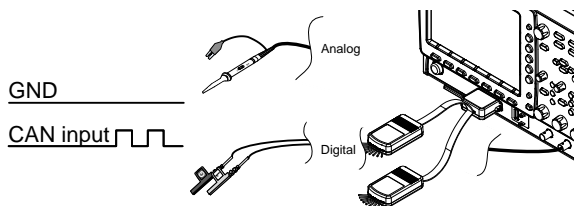

2. Press the *Bus* key.



3. Press *Bus* from the bottom menu and choose the *CAN* serial bus.

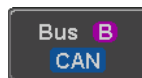

4. Press either *Analog Source* or *Digital Source* to choose whether the source for the CAN bus is analog or digital.



## Define Inputs

5. Press *Define Inputs* from the lower menu.

A rectangular button with rounded corners, a dark grey background, and a yellow border. The text "Define Inputs" is centered in white.

6. From the side menu choose the *CAN Input* inputs and the signal type.

CAN Input CH1~CH4 or D0~D15 \*

Signal CAN\_H, CAN\_L, Tx, Rx.

Type

\*Depending on your choice at step 4 above.



Note

The *Sample Point* soft-key indicates the sampling position of each bit. This parameter is fixed.

## Bit Rate

The *Bit Rate* menu sets the bit rate of the bus. The bit rate is usually tied to the bus length.

7. Press *Bit Rate* from the bottom menu and set the bit rate.

A rectangular button with rounded corners, a dark grey background, and a yellow border. The text "Bit Rate" is in white, and "1Mbps" is in blue below it.

Bit Rate 10kbps, 20kbps, 50kbps, 125kbps,  
250kbps, 500kbps, 800kbps, 1Mbps

## LIN Serial Bus Interface

The local interconnect network (LIN) bus is a single wire interface.

- Panel operation
1. Connect the bus signal (*LIN Input*) to one of the oscilloscope's analog or digital channels. Connect the ground potential to one of the probes' ground clip if you are using the analog channels or to the ground connector of the Digital card if you are the using digital channels.

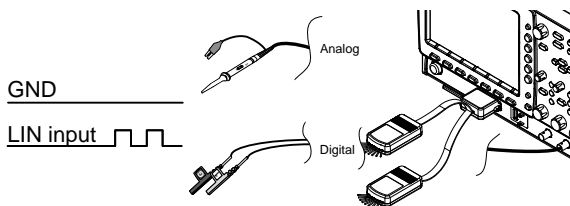

2. Press the *Bus* key.



3. Press *Bus* from the bottom menu and choose the *LIN* serial bus.



4. Press either *Analog Source* or *Digital Source* to choose whether the source for the LIN bus is analog or digital.



- Define Inputs
5. Press *Define Inputs* from the lower menu.

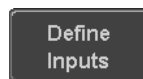

6. From the side menu choose the LIN input and the polarity of the bus.



LIN Input CH1~CH4 or D0~D15 \*

Polarity Normal (High = 1),  
Inverted(High = 0)

\*Depending on your choice at step 4 above.



Note

The *Sample Point* soft-key indicates the sampling position of each bit. This parameter is fixed.

Configuration

The *Configure* menu sets the bit rate, the LIN standard and the parity options for the Id frame.

7. Press *Configure* from the bottom menu.

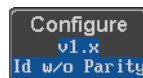

8. From the side menu select configuration items.

Bit Rate 1.2kbps, 2.4kbps, 4.8kbps,  
9.6kbps, 10.417kbps, 19.2kbps

LIN Standard V1.x, V2.x, Both

Include Parity On, Off  
Bits with Id

## Parallel Bus

The digital channels can be configured as a parallel bus. The number of bits that defines the bus as well as which bit is used as the bus clock can also be configured. The trigger should also be set to parallel bus. Please see page 187.

The read data can be displayed as binary, hexadecimal or ASCII. An event table can also be created to aid in debugging.

- Panel operation
1. Connect each of the parallel bus signals (variable length can be configured) to the oscilloscope's digital channels. Connect the ground potential to the ground connector of the Digital card.

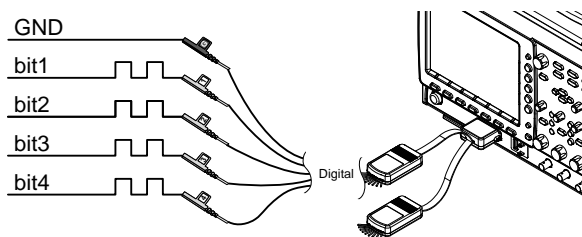

2. Press the *Bus* key.



3. Press the *Bus* soft-key and select Parallel from the side menu.

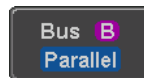

4. Press *Define Inputs* from the bottom menu.

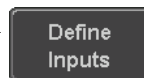

5. Press *Number of Bits* from the side menu and select the number of bits for the data bus.

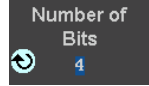

By default the bus will assign bit 0 to D0, bit 1 to D1, and so on up to the last bit.

6. You may also assign a bit as a clock. This bit will be one of the bits in the bus. To add a clock bit, press *Clock Edge* and select type of clock edge. Selecting *Off* will disable the clock bit.



7. If you wish to define which channels are assigned to the bus, press *Select Signal* from the side menu and select the bit that you wish to assign.

Channel 1 is currently assigned to bit 1.



8. Next, press *Select Ch* and select which channel is assigned to the bit selected above.

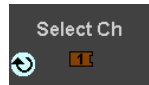

9. Repeat steps 7 and 8 for any remaining bits and for the clock, if enabled.

## Bus Decoding

**Background** The bus that is displayed on the screen or in the event tables can be set to either hex or binary formats.

**Operation** Press *Bus Display* from the Bus menu and choose either Hex or Binary from the side menu.



## Threshold configuration

**Background** The threshold levels for the Serial or Parallel buses can be set to either a user-defined threshold level or to pre-set threshold.

**Set the Threshold** 1. Press *Threshold* from the bottom menu.



2. Press *Select* from the side menu to choose one of the lines that are configured for your type of bus.



UART	Tx, Rx
I <sup>2</sup> C	SCLK, SDA
SPI	SCLK, SS, MOSI, MISO
Parallel	Clock, bit0, bit1, ...
CAN	CAN_H, CAN_L, Tx, Rx
LIN	LIN Input

3. Press *Choose Preset* to select a pre-set logic threshold.

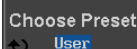

Logic Type	Threshold
------------	-----------

TTL	1.4V
5.0V CMOS	2.5V
3.3V CMOS	1.65V
2.5V CMOS	1.25V
ECL	-1.3V
PECL	3.7V
0V	0V

4. Press *Threshold* to set a user defined threshold for the currently selected input.

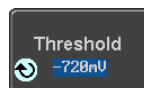

For the analog channels, the threshold level depends on the vertical scale :

Scale	Range	Scale	Range
10V/Div	±290V	50mV/Div	±5.2V
5V/Div	±270V	20mV/Div	±580mV
2V/Div	±33V	10mV/Div	±540mV
1V/Div	±29V	5mV/Div	±520mV
500mV/Div	±27V	2mV/Div	±508mV
200mV/Div	±5.8V	1mV/Div	±504mV
100mV/Div	±5.4V		

For the digital channels, only the following range can be chosen:

Range      ±5V



Setting the threshold levels of digital channels from the Bus menu will also change the threshold levels set in the Logic Analyzer menu (page 217).

## Serial or Parallel Bus Event Tables

**Background**      The serial bus event tables list when each data event on the bus occurred. The data is displayed as either hex or binary, depending on the bus display settings.

Event tables can be saved to disk in a CSV format. The files will be named "Event\_TableXXXX.CSV", where XXXX is a number from 0000 to 9999. See page 146 for details.

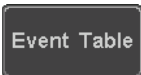
**Operation**      1. Press *Event Table* from the bottom menu. 

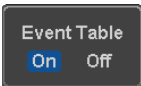
2. Press *Event Table* from the side menu to turn the event table on or off.   
    Event      On, Off

Use the Variable knob to scroll through the event table.

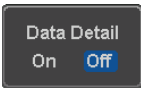
**Data Detail (I<sup>2</sup>C only)**      3. To view the data at a particular address in more detail, turn *Data Detail* On. This is only available for the I<sup>2</sup>C bus.   
    Detail      On, Off

Use the Variable knob to scroll through the Data Detail event table.

- Save Event Table 4. To save the event table, press *Save Event Table*. The Event table will be saved to the current file path in a CSV format. See page 146 for details.



Use the variable knob to scroll through the event table.

Example:  
UART Event table

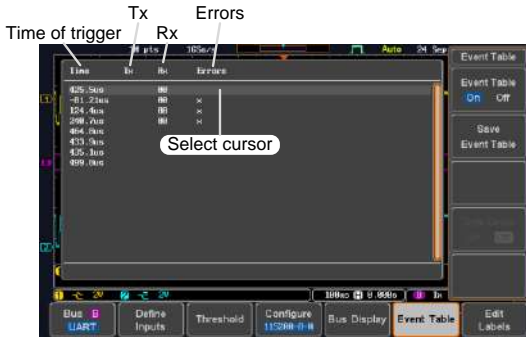

Example:  
I<sup>2</sup>C Event table

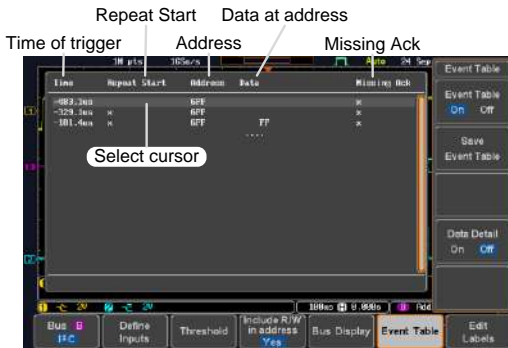

Example:  
I<sup>2</sup>C Data Detail

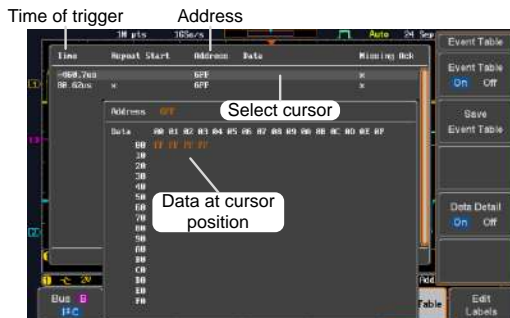

Note Data Detail is only available with the I<sup>2</sup>C bus.

Example:  
SPI Event table



Example:  
CAN Event table

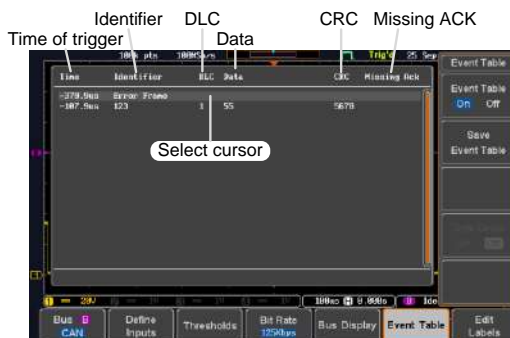



Example:  
LIN Event table

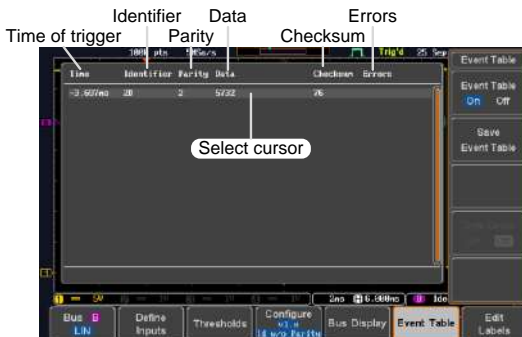

Example:  
Parallel Bus Event table

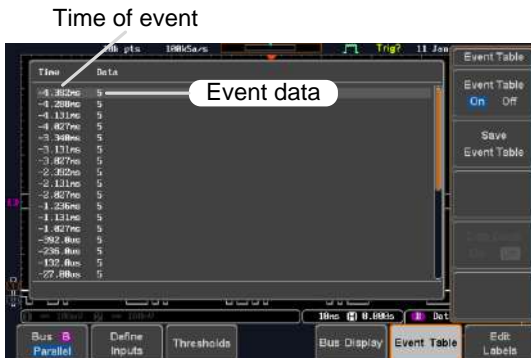

## Event Tables Format

Each bus type (UART, I<sup>2</sup>C, SPI, Parallel, CAN and LIN) can have an event table saved containing each bus event as a .CSV file. An event is defined as a packet/frame/word or associated set of data being successfully read according to the specific operating conditions of each bus (Start of frame, acknowledgements, checksums, etc ...).

The data associated with each event and the time of each event is recorded.

**File Type** Each event table is saved as Event\_TableXXXX.CSV into the designated file path. Each event table is numbered sequentially from 0000 to 9999. For example the first event table will be saved as Event\_Table0000.CSV, the second as Event\_Table0001.CSV, and so on.

**Event Table Data** Each event table saves a timestamp of each event relative to the trigger as well as the data in each frame/packet at the time of an event. The frame/packet data is saved in HEX format.

The table below lists in order the data saved for each event table.

UART	Time, Tx frame data, Rx frame data, Errors.
I <sup>2</sup> C	Time, Repeat Start, Address, Data, Missing Ack.
SPI	Time, MISO frame data, MOSI frame data.
CAN	Time, Identifier, DLC, Data, CRC, Missing Ack.
Parallel	Time, Data.
LIN	Time, Identifier, Parity, Data, Checksum, Errors.

Example Below shows the data associated with an SPI event table in a spreadsheet.

Time	MOSI	MISO
-11.60us	0D87	0D87
-10.16us	06C0	06C0
-8.720us	8343	343
-7.282us	243	243
-5.840us	0C88	0C88

## Adding a Label to a Bus

---

Background A Label can be added to the buses. This label will appear next to the bus indicator on the left hand-side of the display.

---

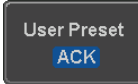
- Panel Operation
- To add a label to the bus, press *Edit Labels* from the Bus menu. 
  - To choose a preset label, Press *User Preset* from the side menu and choose a label. 

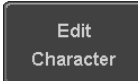
Labels ACK, AD0, ADDR, ANALOG, BIT, CAS, CLK, CLOCK, CLR, COUNT, DATA, DTACK, ENABLE, HALT, INT, IN, IRQ, LATCH, LOAD, NMI
- Edit Label
- Press *Edit Character* to edit the current label. 

- The Edit Label window appears.

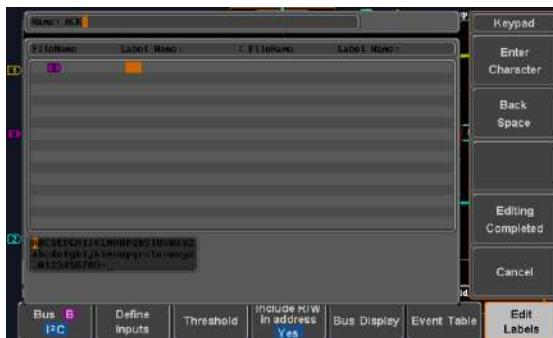

- Use the Variable knob to highlight a character.

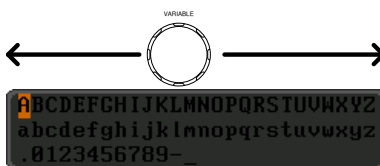

Press *Enter Character* to select a number or letter.

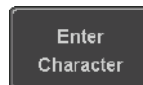

Press *Back Space* to delete a character.



Press *Editing Completed* to create the new label and return to the previous menu.

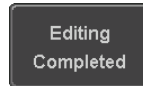

Note: this key must be pressed to save the label, even for the preset labels.

Press *Cancel* to cancel the editing and return to the Edit Label menu.

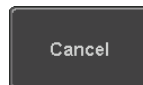

6. The label will appear next to the bus indicator.

Below, the label "ACK" was created for the bus.



Remove Label

Press *Label Display* to toggle the label on or off.

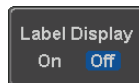

## Using Cursors with the Serial or Parallel Bus

---

Background

The cursors can be used to read bus values at any position.



Note

Ensure that one of the serial buses has been selected and is activated.

Panel Operation

1. Press the *Cursor* key. Horizontal cursors appear on the display.



2. Press the *H Cursor* soft-key and select which cursor(s) you wish to position.

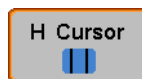

Range	Description
∷	Left cursor (1) movable, right cursor position fixed
∷	Right cursor (2) movable, left cursor position fixed
∷	Left and right cursor (1+2) movable together

- The cursor position information appears on the top left hand side of the screen.

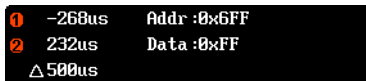

Example: I<sup>2</sup>C cursors.

Cursor 1 Hor. position, Bus value(s)

Cursor 2 Hor. position, Bus value(s)

- Use the *Variable knob* to move the movable cursor(s) left or right.

VARIABLE

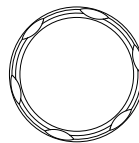

# Trigger

The trigger configures the conditions for when the MSO-2000E/2000EA captures a waveform.

## Trigger Type Overview

---

**Edge**                      The edge trigger is the simplest trigger type. An edge trigger triggers when the signal crosses an amplitude threshold with either a positive or negative slope.

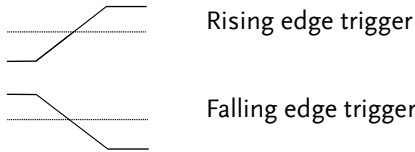

**Delay**                      The Delay trigger works in tandem with the edge trigger, by waiting for a specified time (duration) or number of events before the delay trigger starts. This method allows pinpointing a location in a long series of trigger events.

Note: when using the delay trigger, the edge trigger source can be any one of the channel inputs, the EXT\* input or the AC line.

\*EXT is only available on 2 channel models.

Delay trigger example (by event)

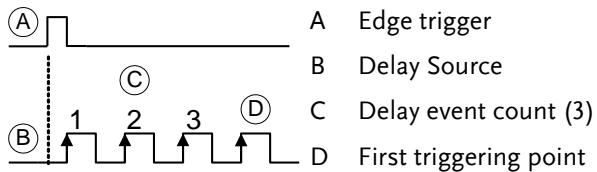

Delay trigger example (by time)

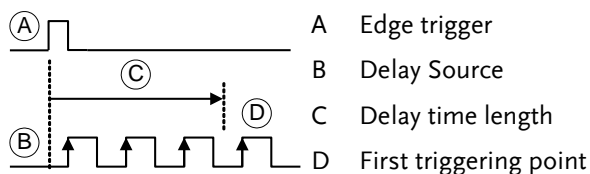

Pulse Width

Triggers when the pulse width of the signal is less than, equal, not equal or greater than a specified pulse width.

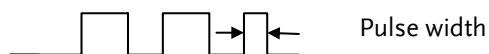

Video

Extracts a sync pulse from a video format signal, and triggers on a specific line or field.

Pulse and Runt

Triggers on a "runt". A runt is a pulse that passes a specified threshold but fails to pass a second threshold. Both positive and negative runts can be detected.

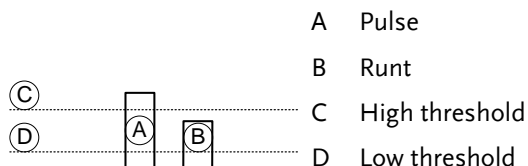

Rise and Fall (Slope)

Trigger on rising and or falling edges, below or over a specified rate. The threshold can also be specified.

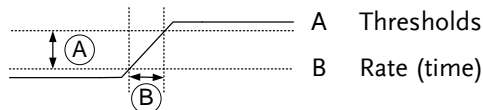



**Timeout** Triggers when the signal stays high, low or either for a designated amount of time. The trigger level determines when a signal is high or low.

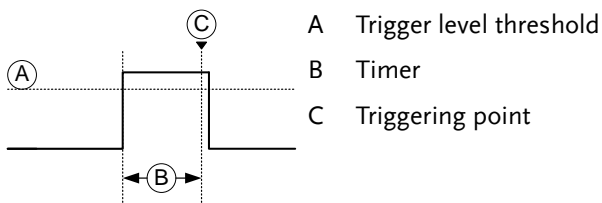

**Bus** Triggers on SPI, UART, I2C, Parallel, CAN or LIN bus events.

**Logic** Triggers on specified logic levels or for specified clock edge. Logic trigger is only available for Digital channels.

### Trigger: types and sources

Sources versus types

Trigger types	Trigger sources			
	Analog			Digital
	CH1 ~ CH4	EXT*	AC Line	D0 ~ D15
Edge	√	√	√	√
Delay	√	√	√	
Pulse Width	√	√	√	√
Video	√			
Pulse & Runt	√			
Rise & Fall (Slope)	√			
Timeout	√	√	√	√
Bus	√ **			√ **
Logic				√

\*Only for two channels model.

\*\*The source (analog or digital) is assigned from the Bus menu.

## Trigger Parameter Overview

All the following parameters are common for all the trigger types unless stated otherwise.

Trigger Source	CH1 ~ 4	Channel 1 ~ 4 input signals Except for: Logic	
	EXT *	External trigger input signal Except for: Video, Pulse Runt, Rise & Fall, Bus and Logic *Only for 2 input models.	EXT TRIG 
	AC Line	AC mains signal Except for: Video, Pulse Runt, Rise & Fall, Bus and Logic	
	D0 ~ D15	Digital input channels Except for: Video, Pulse Runt, Rise and Fall	
	Alternate	Alternate between channel sources for the trigger source.	
	EXT Probe	For EXT trigger source only. Set the probe as either current or voltage.	
	Attenuation	For EXT trigger source only. Attenuates the EXT trigger probe by an adjustable value.	
		Range	0.001X ~ 1000X 1-2-5 steps
Source Bus	UART	UART bus	

I <sup>2</sup> C	Inter-Integrated Circuit
SPI	Serial Peripheral Bus
Parallel	Parallel bus
CAN	Controller Area Network bus
LIN	Local Interconnect Network



Note



The Source Bus is not configurable from the Trigger menu. The field is automatically filled according to the Bus menu configuration (see page 124).



Trigger Mode	Auto (un-triggered roll)	The MSO-2000E/2000EA generates an internal trigger if there is no trigger event, to make sure waveforms are constantly updated regardless of trigger events. Select this mode especially when viewing rolling waveforms at slower timebases.
	Normal	The MSO-2000E/2000EA acquires a waveform only when a trigger event occurs.
	Single	When pressing the Single key, the MSO-2000E/2000EA acquires a waveform only once when a trigger event occurs, and then stops acquiring (the oscilloscope falls into Stop mode). Press the Single key to acquire a waveform again. Please refer to Run/Stop mode for more details (page 46).



Coupling (Edge, Delay, Timeout)	DC	DC coupling.
	AC	AC coupling. Blocks DC components from the trigger circuits *.
	HF reject	High frequency filter, above 70kHz *.
	LF reject	Low frequency filter, below 70kHz *.
	Reject noise	DC coupling with low sensitivity to reject noise.

\*Parameter not applicable to digital channels.

Slope (Edge, Delay, Rise & Fall)		Trigger on a rising edge.
		Trigger on a falling edge.
		Either (either rising or falling edge).

Trigger Level (Edge, Delay)	Level	Adjusts the trigger level manually using the Trigger LEVEL knob.	
	Set to TTL 1.4V	Sets the trigger level to 1.4V, suitable for triggering on TTL signals.	
	Set to ECL - 1.3V	Sets the trigger to -1.3V. This is suitable for ECL circuits.	
	Set to 50%	Sets the trigger level to 50% of the waveform amplitude.	

Level (Edge, Delay) Only available when the trigger source is digital.

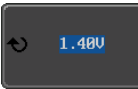
Level	Adjusts the trigger level when the source is digital.	
Range		-5V ~ +5V

Choose Preset Press *Choose Preset* to select a pre-set logic threshold.

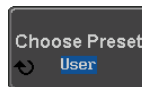

Logic Type	Threshold
TTL	1.4V
5.0V CMOS	2.5V
3.3V CMOS	1.65V
2.5V CMOS	1.25V
ECL	-1.3V
PECL	3.7V
0V	0V



Note

Setting the trigger levels for the digital sources will also change the threshold levels set in the Logic Analyzer menu (page 217).

Holdoff	Holdoff	Sets the holdoff time.		
	Set to Minimum	Set the holdoff time to the minimum.		
Delay (Delay)	Time	Sets the delay time (4ns ~ 10s) between the trigger event and the real trigger timing.		
	Event	Sets the number of events (1 ~ 65535) passed after the trigger event, until the real trigger timing.		
	Set to Minimum	Sets the source trigger to the minimum time.		
When (Pulse Width)	Sets the pulse width (4ns ~ 10s) and the triggering condition.			
	>	Longer than	=	Equal to
	<	Shorter than	≠	Not equal to

Threshold (Pulse Width)      Sets the amplitude threshold level for the pulse widths.

Threshold      -XXV ~ +XXV, user-set level

Set to TTL      1.4V

Set to ECL      -1.3V

Set to 50%      Sets the threshold to 50%

(Only when the trigger source is digital):

Threshold      Adjusts the amplitude threshold for the pulse width trigger when the source is digital.



Range      -5V ~ +5V

Choose Preset      Press *Choose Preset* to select a pre-set logic threshold.

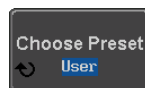





Logic Type	Threshold
TTL	1.4V
5.0V CMOS	2.5V
3.3V CMOS	1.65V
2.5V CMOS	1.25V
ECL	-1.3V
PECL	3.7V
0V	0V







Note

Setting the threshold levels for the digital sources from the Trigger menu will also change the threshold levels set in the Logic Analyzer menu (page 217).

Standard (Video)	NTSC	National Television System Committee
	PAL	Phase Alternate by Line

	SECAM	SEquential Couleur A Memoire
Polarity (Pulse Width, Video)		Positive polarity (triggered on the high to low transition)
		Negative polarity (triggered on the low to high transition)
Polarity (Pulse Runt)		Positive polarity (positive runt)
		Negative polarity (negative runt)
		Either (either negative or positive runt)
Trigger On (Video)	Odd Field	NTSC: 1 ~ 263 PAL/SECAM: 1 ~ 313 EDTV: 1~525(480P), 1~625(576P) HDTV: 1~750(720P), 1~563(1080i), 1~1125(1080P)
	Even Field	NTSC: 1 ~ 262, PAL/SECAM: 1 ~ 312 HDTV: 1~562(1080i)
	All Fields	Triggers on all fields.
	All Lines	Triggers on all lines.
Trigger On (Bus)	UART Bus	Tx Start Bit, Rx Start Bit, Tx End of Packet, Rx End of Packet, Tx Data, Rx Data, Tx Parity Error, Rx Parity Error
	I <sup>2</sup> C	Start, Repeat Start, Stop, Missing Ack, Address, Data, Address/Data
	SPI	SS Active, MOSI, MISO, MOSI&MISO
	CAN	Start of Frame, Type of Frame, Identifier, Data, Id & Data, End of Frame, Missing Ack, Bit Stuffing Err
	LIN	Sync, Identifier, Data, Id & Data, Wakeup Frame, Sleep Frame, Error

Data (Bus)	Selects the conditions for the parallel bus trigger.	
	Parallel	A Binary or Hexadecimal word.
Threshold (Pulse Runt)		Sets the upper threshold limit.
		Sets the lower threshold limit.
Threshold (Rise & Fall)		Sets the High threshold.
		Sets the Low threshold.
Trigger When (Timeout)	Stays High	Triggers when the input signal stays high for a designated amount of time.
	Stays Low	Triggers when the input signal stays low for a designated amount of time.
	Either	Triggers when the input signal stays high or low for a designated amount of time.
Timer (Timeout)	4nS~10.0S	Sets the amount of time that a signal must stay high or low for the timeout trigger.



## Setup Holdoff Level

**Background** The holdoff function defines the waiting period before the MSO-2000E/2000EA starts triggering again after a trigger point. The holdoff function ensures a stable display if there are a number of points in a periodic waveform that can be triggered. Holdoff applies to all the triggering types except the trigger by bus.

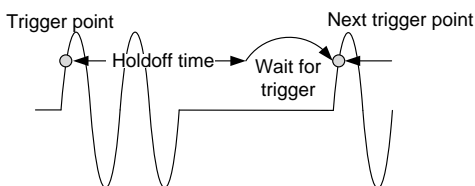

**Panel Operation** 1. Press the trigger *Menu* key.



2. To set the Holdoff time, press the *Holdoff* (or *Mode/Holdoff*) menu button on the bottom bezel.



3. Use the side menu to set the Holdoff time.



Range 4ns~10s

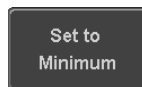

Pressing *Set to Minimum* sets the Holdoff time to the minimum, 4ns.







Note: The holdoff function is automatically disabled when the waveform update mode is in roll mode (page 110).

## Setup Trigger Mode

**Background** The trigger mode can be set to Normal or Auto (untriggered roll). The triggering mode applies to all the trigger types.

- Panel Operation**
1. Press the Trigger menu key. 
  2. Press *Mode* from the bottom menu to change the triggering mode. 
  3. Use the side panel to select *Auto* or *Normal* triggering modes.  
 Range      Auto, Normal

## Using the Edge Trigger

- Panel Operation**
1. Press the trigger *Menu* key. 
  2. Press *Type* from the lower bezel menu. 
  3. Select *Edge* from the side menu. The edge trigger indicator appears at the bottom of the display.   
  
 From left: trigger source, slope, trigger level, coupling
  4. Press *Source* to change the trigger source. 
  5. Use the side menu to select the trigger source type.

Range Channel 1 ~ 4 (Alternate On/Off),  
EXT (Ext Probe: Volt/Current,  
Attenuation: 1mX~1kX, CH2  
models only), AC Line, D0 ~ D15.

- Press *Coupling* from the bottom bezel menu to select the trigger coupling or frequency filter settings.

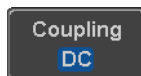

Choose the coupling from the side menu.

Range DC, AC, HF Reject, LF Reject

- Toggle *Noise Rejection* On or Off from the side menu.

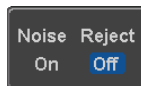

Range On, Off

- From the bottom menu press *Slope* to toggle the slope type.



Range Rising edge, falling edge, either

- To set the external trigger level, select *Level* from the bottom bezel menu (Not applicable for AC line source).

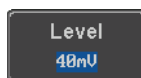

10. Set the external trigger level using the side menu.



Analog channel Range	00.0V~ 5 screen divisions
	Set to TTL 1.4V
	Set to ECL -1.3V
	Set to 50%

Digital channel Range	-5.00V~ +5.00V	
	TTL	1.4V
	5.0V CMOS	2.5V
	3.3V CMOS	1.65V
	2.5V CMOS	1.25V
	ECL	-1.3V
	PECL	3.7V
	0V	0V



Setting the trigger level for a digital source will also change the threshold levels set in the Logic Analyzer menu (page 217).

## Using Advanced Delay Trigger

Panel Operation 1. Set the edge trigger source. This will set the initializing trigger for the delay source. Page 162

2. Press the trigger *Menu* key.



3. Press *Type* from the lower bezel menu.



4. Select *Delay* from the side menu.  
The delay trigger indicator appears at the bottom of the display.

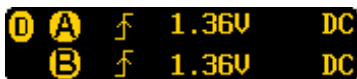

From left: Delay trigger indicator (D), edge trigger (A), edge slope, edge level, edge coupling, delay trigger (B), delay slope, delay trigger level, delay coupling.

5. To set the delay source, press *Source* and select a source from the side menu.



Source CH1 ~ CH4, AC Line, EXT\*  
\*2 channel models only.

6. Press *Coupling* from the bottom bezel menu to select the trigger coupling or frequency filter settings.

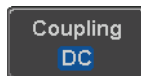

Choose the coupling from the side menu.

Range DC, AC, HF Reject, LF Reject

7. To set the delay press *Delay* from the bottom bezel.

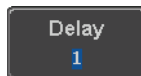

8. To Delay by Time (Duration), press *Time* from the side menu and set the delay time.



Range      4ns ~ 10s (by time)  
 Set to minimum

9. To Delay by Event, press *Event* from the side menu and set the number of events.

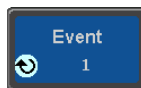

Range      1 ~ 65535 events  
 Set to Minimum

### Using Pulse Width Trigger

- Panel Operation 1. Press the trigger *Menu* key.



2. Press the *Type* key from the lower bezel menu.



3. Select *Pulse Width* from the side menu. The pulse width trigger indicator appears at the bottom of the display.



From left: source, polarity, when, coupling

4. Press *Source* from the lower bezel.



5. Use the side menu to select the pulse width trigger source.

Range Channel 1 ~ 4 (Alternate On/Off),  
EXT (Ext Probe: Volt/Current,  
Attenuation: 1mX~1kX, CH2  
models only), AC Line, D0 ~ D15.

6. Press *Polarity* to toggle the polarity type.

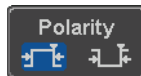

Range Positive (high to low transition)  
Negative (low to high transition)

7. Press *When* from the lower bezel.

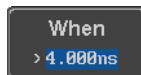

Then use the side menu to select the pulse width condition and width.

Condition > , < , = , ≠

Width 4ns ~ 10s

8. Press *Threshold* from the lower bezel to edit the pulse width threshold.

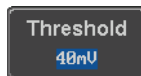

9. Set the threshold level using the side menu.



Analog channel Range	00.0V~ 5 screen divisions
	Set to TTL 1.4V
	Set to ECL -1.3V
	Set to 50%





Digital channel Range	-5.00V~ +5.00V	
	TTL	1.4V
	5.0V CMOS	2.5V
	3.3V CMOS	1.65V
	2.5V CMOS	1.25V
	ECL	-1.3V
	PECL	3.7V
	0V	0V



Setting the trigger threshold for a digital source will also change the threshold levels set in the Logic Analyzer menu (page 217).

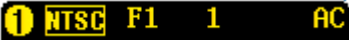

## Using Video Trigger

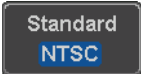
- Panel Operation
1. Press the trigger *Menu* key. 
  2. Press the *Type* key from the lower bezel menu. 
  3. Select *Video* from the side menu. The video trigger indicator appears at the bottom of the display.   
  
 From left: source, video standard, field, line, coupling
  4. Press *Source* from the lower bezel. 
  5. Use the side menu to select the video trigger source.  
 Range Channel 1 ~ 4
  6. Press *Standard* on the bottom bezel.   
 Use the side menu to select the video standard.  
 Range NTSC, PAL, SECAM, EDTV(480P, 576P), HDTV(720P, 1080i, 1080P)

7. Press *Trigger On* to edit the video field and line.

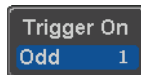

Use the side menu to select the field and line.

Odd Field NTSC: 1 ~ 263  
 PAL/SECAM: 1 ~ 313  
 EDTV: 1~525(480P), 1~625(576P)  
 HDTV: 1~750(720P), 1~563(1080i),  
 1~1125(1080P)

Even Field NTSC: 1 ~ 262  
 PAL/SECAM: 1 ~ 312  
 HDTV: 1~562(1080i)

All Fields Triggers on all fields.

All Lines Triggers on all lines.

8. Press *Polarity* to toggle the polarity type.

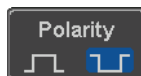

Range positive, negative

## Pulse Runt trigger

---

- Panel Operation
1. Press the trigger *Menu* key.



2. Press the *Type* key from the lower bezel menu.



3. Select *Others* → *Pulse Runt* from the side menu. The Pulse and Runt indicator appears at the bottom of the display.

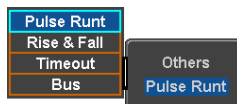



From left: polarity, source, high/low threshold, threshold level, coupling

4. Press *Source* from the lower menu.



Use the side menu to select a source.

Range Channel 1 ~ 4(Alternate On/Off)

5. Press *Polarity* to toggle the polarity.



Range Rising edge, falling edge, either.

6. Press *When* from the lower menu.

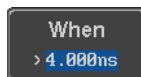

Then use the side menu to select the condition and width.

Condition >, <, =, ≠

Width 4ns ~ 10s

7. Press *Threshold* from the lower bezel to edit the threshold for the upper and lower threshold.



8. Use the side menu to set the upper threshold.



Range -XXV~XXV

9. Use the side menu to set the lower threshold.



Range -XXV~XXV

## Using Rise and Fall Trigger

Panel Operation 1. Press the trigger *Menu* key.



2. Press the *Type* key from the lower bezel menu.



3. Select *Others* → *Rise and Fall* from the side menu. The Rise and Fall indicator appears at the bottom of the display.

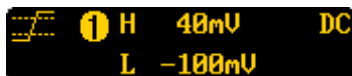
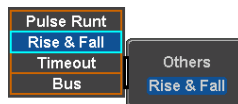

From left: slope, source, high/low threshold, threshold level, coupling

4. Press *Source* from the lower menu.



Use the side menu to select a source.

Range Channel 1 ~ 4(Alternate On/Off)

5. Press *Slope* from the bottom menu to toggle the slope.



Range Rising edge, falling edge, either

6. Press *When* from the lower menu.

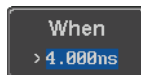

Then use the side menu to select the logic conditions and true or false status.

Condition > , < , = , ≠

Width 4ns ~ 10s

7. Press *Threshold* from the lower bezel to edit the High and Low threshold.



Range High: -XXV~XXV  
Low: -XXV~XXV

## Using the Timeout Trigger

- Panel Operation 1. Press the trigger *Menu* key.



2. Press the *Type* key from the lower bezel menu.



3. Select *Others* → *Timeout* from the side menu. The Timeout indicator appears at the bottom of the display.

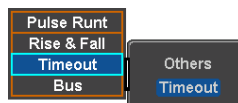

**1 Timeout 1.40V DC**

From left: Source, Trigger type, threshold level, coupling

4. Press *Source* from the lower menu.



Use the side menu to select a source.

Range Channel 1 ~ 4 (Alternate On/Off), EXT (Ext Probe: Volt/Current, Attenuation: 1mX~1kX, CH2 models only), AC Line, D0 ~ D15.

5. Press *Coupling* from the bottom bezel menu to select the trigger coupling or frequency filter settings.

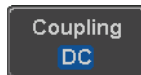

Choose the coupling from the side menu.

Range DC, AC, HF Reject, LF Reject

6. Toggle *Noise Rejection* On or Off from the Coupling side menu.

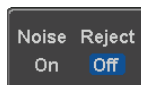

Range On, Off

7. Press *Trigger When* from the lower menu.



Then use the side menu to select trigger conditions.

Condition Stays High, Stays Low, Either

8. Press *Level* from the lower bezel to set the trigger level.

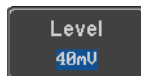

9. Set the level using the side menu.



Analog channel	00.0V~ 5 screen divisions
Range	Set to TTL 1.4V
	Set to ECL -1.3V
	Set to 50%

Digital channel	-5.00V~ +5.00V	
Range	TTL	1.4V
	5.0V CMOS	2.5V
	3.3V CMOS	1.65V
	2.5V CMOS	1.25V
	ECL	-1.3V
	PECL	3.7V
	0V	0V



Setting the trigger threshold for a digital source will also change the threshold levels set in the Logic Analyzer menu (page 217).

10. Press *Timer* from the lower bezel to set the timer time.

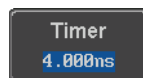

Range	4ns~10.0s
-------	-----------

## Using the Bus Trigger

The Bus trigger is used to trigger the oscilloscope on UART, I2C, SPI, CAN or LIN serial bus signals or on parallel bus data.

### UART BUS Trigger Settings

The UART bus trigger conditions can be set at any time after the bus settings have been set to *UART*.

Panel Operation 1. Set the Bus to UART in the bus menu. Page 128

2. Press the *Trigger Menu* key.



3. Press *Type* from the bottom menu.



4. Press *Others* from the side menu and select *Bus*.



The Trigger on settings will be reflected on the Trigger Configuration icon.



From left: Bus trigger, Trigger source

5. Press *Trigger On* and select the triggering condition for the UART bus.

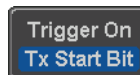

Trigger On Tx Start Bit, Rx Start Bit, Tx End of Packet, Rx End of Packet, Tx Data, Rx Data, Tx Parity Error, Rx Parity Error

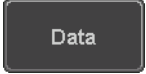

Trigger On – Tx Data, Rx Data      If Tx Data or Rx Data was configured for the Trigger On setting, then the number of bytes and data can also be configured.

6. Press *Data* from the bottom menu. 

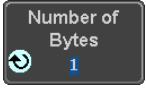
7. Press *Number of Bytes* from the side menu and choose the number of bytes for the data. 

UART      1~10 Bytes

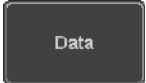
8. Press *Data* from the side menu to edit the triggering data. 

To edit the data, use the *Variable* knob to highlight a binary or hex digit and press *Select*. Use the *Variable* knob to choose a value for the digit and press *Select* to confirm.

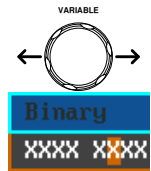



- Binary      0,1,X (don't care)
- Hex          0~F, X (don't care)
- ASCII      ASCII characters for the equivalent Hex characters 00 to FF

### I<sup>2</sup>C Bus Trigger Settings

The I<sup>2</sup>C bus trigger conditions can be set at any time after the bus settings has been set to I<sup>2</sup>C.

Panel Operation      1. Set the Bus to I<sup>2</sup>C in the bus menu.      Page 130

2. Press the *Trigger Menu* key. 

- 3. Press *Type* from the bottom menu. 

- 4. Press *Others* from the side menu and select *Bus*. 

The Trigger on settings will be reflected on the Trigger Configuration icon.

**B Data**

From left: Bus trigger, Trigger source

- 5. Press *Trigger On* and select the triggering condition for the selected bus. 

Trigger On Start, Repeat Start, Stop, Missing Ack, Address, Data, Address/Data

**Trigger On – Data**      If Data or Address/Data was configured for the Trigger On setting, then the number of bytes, data and addressing mode (I<sup>2</sup>C) can be configured.

- 6. Press *Data* from the bottom menu. 

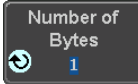
- 7. Press *Number of Bytes* from the side menu and choose the number of bytes for the data. 

I<sup>2</sup>C      1~5 Bytes

- 8. Press *Addressing Mode* to toggle between 7 and 10 bit addressing modes. 

9. Press *Data* from the side menu to edit the triggering data.

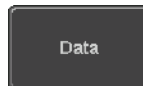

To edit the data, use the *Variable* knob to highlight a binary or hex digit and press *Select*. Use the *Variable* knob to choose a value for the digit and press *Select* to confirm.

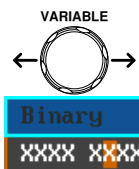

Binary      0,1,X (don't care)

Hex          0~F, X (don't care)

Trigger On -  
Address

If Address or Address/Data was configured for the Trigger On setting, then the triggering address must be configured.

10. Press *Address* on the bottom menu.

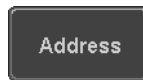

11. Press *Addressing Mode* to toggle between 7 and 10 bit addressing modes.



12. To choose a preset address as the default address, press *Choose Preset* and select a preset address.

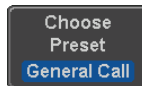

Address	Description
0000 000 0	General Call
0000 000 1	START Byte
0000 1XX X	Hs-mode
1010 XXX X	EEPROM
0000 001 X	CBUS

Press *Apply Preset* to set the default address to the preset.



**Note**

- Presets are not available for *Trigger On Address/Data*.

13. Press *Address* from the side menu to manually edit the triggering address.

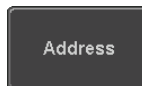

To edit the address, use the *Variable* knob to highlight a binary or hex digit and press *Select*. Use the *Variable* knob to choose a value for the digit and press *Select* to confirm.

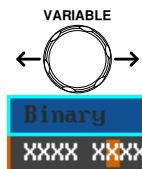

Binary	0,1, X (don't care)
Hex	0~F, X (don't care)

**Direction**

14. Press *Direction* on the bottom menu and choose the direction from the side menu.

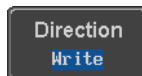

Direction	Write, Read, Read or Write
-----------	----------------------------

### SPI Bus Trigger Settings

The SPI bus trigger conditions can be set at any time after the bus setting has been set to SPI.

Panel Operation 1. Set the Bus to SPI in the bus menu. Page 132

2. Press the *Trigger Menu* key.



3. Press *Type* from the bottom menu.



4. Press *Others* from the side menu and select *Bus*.

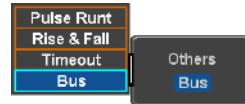

The Trigger on settings will be reflected on the Trigger Configuration icon.



From left: Bus trigger, Trigger source

5. Press *Trigger On* and select the triggering condition for the SPI bus.



SPI SS Active, MOSI, MISO, MOSI&MISO

### Trigger On – Data

If MOSI, MISO or MISO/MOSI was configured for the Trigger On setting, then the number of words and the data can be configured.

6. Press *Data* from the bottom menu.



7. Press *Number of Words* from the side menu and choose the number of words for the data.



SPI      1~32 Words

8. Press *MOSI* or *MISO* from the side menu to edit the triggering data.

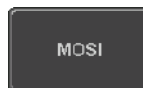

To edit the data, use the *Variable* knob to highlight a binary or hex digit and press *Select*. Use the *Variable* knob to choose a value for the digit and press *Select* to confirm.

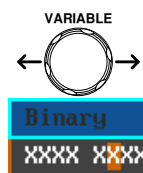

Binary      0,1,X (don't care)

Hex          0~F, X (don't care)

### CAN Bus Trigger

The CAN bus trigger conditions can be set at any time after the bus setting has been set to CAN.

- Panel Operation    1. Set the Bus to CAN in the bus menu.

Page 134

2. Press the *Trigger Menu* key.



3. Press *Type* from the bottom menu.



4. Select *Others* → *Bus* from the side menu. The Bus indicator appears at the bottom of the display.



The Trigger on settings will be reflected on the Trigger Configuration icon.

**B Id & Data**

From left: Bus trigger, Trigger source

5. Press *Trigger On* and select the triggering condition for the selected bus.



Trigger On Start of Frame, Type of Frame, Identifier, Data, Id & Data, End of Frame, Missing Ack, Bit Stuffing Err

Trigger On –Type of Frame

6. If *Type of Frame* was configured for the Trigger On setting, then the type of frame can be configured from the side menu.

Type Data Frame, Remote Frame, Error Frame, Overload Frame

Trigger On – Identifier

7. If *Identifier/Id & Data* was configured for the Trigger On setting, select the format from the side menu.

Format Standard, Extended

8. Press *Identifier* from the side menu to set the identifier data.

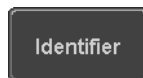

To edit the identifier, use the *Variable* knob to highlight a binary or hex digit and press *Select*. Use the *Variable* knob to choose a value for the digit and press *Select* to confirm.

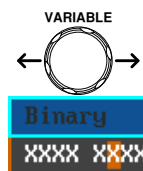

Binary 0,1,X (don't care)

Hex 0~F, X (don't care)

9. Press *Direction* on the bottom menu and select the *CAN Direction* from the side menu.



CAN Direction Write, Read, Read or Write

**Trigger On - Data**

If *Data/Id and Data* was configured for the *Trigger On* setting, then the triggering data must be configured.

10. Press *Data* on the bottom menu.



11. Press *Number of Bytes* from the side menu and choose the number of bytes for the data.

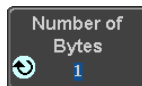

Bytes 1~8 Bytes

12. Press *Data* from the side menu to edit the triggering data.

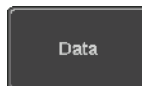

To edit the data, use the *Variable* knob to highlight a binary or hex digit and press *Select*. Use the *Variable* knob to choose a value for the digit and press *Select* to confirm.

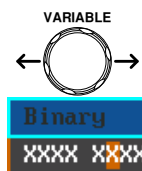

Binary 0,1,X (don't care)

Hex 0~F, X (don't care)

13. Press *Trigger When* from the side menu to choose the triggering condition for the data.

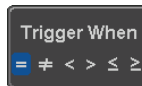

When =, ≠, <, >, ≤, ≥



14. The oscilloscope will now trigger when the specified bus data matches the *Trigger When* conditions.

### LIN Bus Trigger

The LIN bus trigger conditions can be set at any time after the bus setting has been set to LIN.

Panel Operation 1. Set the Bus to LIN in the bus menu. Page 136

2. Press the *Trigger Menu* key.



3. Press *Type* from the bottom menu.



4. Select *Others* → *Bus* from the side menu. The Bus indicator appears at the bottom of the display.



From left: Bus trigger, Trigger source

5. Press *Trigger On* and select the triggering condition for the selected bus.



Trigger On Sync, Identifier, Data, Id and Data, Wakeup Frame, Sleep Frame, Error.

Trigger On – Identifier

6. If *Identifier* or *Id & Data* was configured for the Trigger On setting, press *Identifier* from the bottom menu.

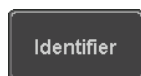

7. Press *Identifier* from the side menu to set the identifier data.

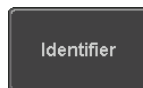

To edit the identifier, use the *Variable* knob to highlight a binary or hex digit and press *Select*. Use the *Variable* knob to choose a value for the digit and press *Select* to confirm.

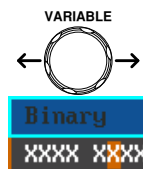

Binary 0,1,X (don't care)

Hex 0~F, X (don't care)

**Trigger On - Data**

If *Data/Id and Data* was configured for the Trigger On setting, then the triggering data must be configured.

8. Press *Data* on the bottom menu.



9. Press *Number of Bytes* from the side menu and choose the number of bytes for the data.

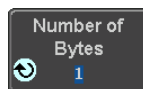

Bytes 1~8 Bytes

10. Press *Data* from the side menu to edit the triggering data.

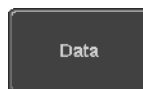

To edit the data, use the *Variable* knob to highlight a binary or hex digit and press *Select*. Use the *Variable* knob to choose a value for the digit and press *Select* to confirm.

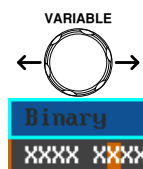

Binary 0,1,X (don't care)

Hex 0~F, X (don't care)

11. Press *Trigger When* from the side menu to choose the triggering condition for the data.

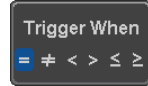

When =, ≠, <, >, ≤, ≥

12. The oscilloscope will now trigger when the specified bus data matches the *Trigger When* conditions.

### Parallel Bus Trigger

The parallel bus trigger conditions can be set at any time after the bus setting has been set to parallel. The parallel bus can be set up to trigger on a specified data pattern.

- Panel Operation
1. Set the Bus to parallel in the bus menu. Page 138

2. Press the *Trigger Menu* key.



3. Press *Type* from the bottom menu.



4. Select *Others* → *Bus* from the side menu. The Bus indicator appears at the bottom of the display.



From left: Bus trigger, Data source

5. Press *Data* from the bottom menu.

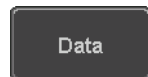

6. Press *Data* from the side menu to edit the triggering data.

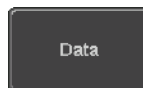

To edit the data, use the *Variable* knob to highlight a binary or hex digit and press *Select*. Use the *Variable* knob to choose a value for the digit and press *Select* to confirm.

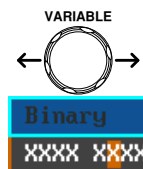

- Binary     0,1,X (don't care)
- Hex        0~F, X (don't care)

7. The oscilloscope will now trigger when the specified data appears on the bus.

## Using the Logic Trigger

---

### Background

The digital channels can be set up to trigger on specified logic levels and for a specified clock edge.

For example the digital channels can be set to trigger on the rising edge of a clock signal when bit 1 of a digital channel is high and all other channels are ignored.

### Panel Operation

1. Press the *Trigger Menu* key.

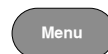

2. Press *Type* from the bottom menu.



3. Select *Others* → *Logic* from the side menu. The Logic indicator appears at the bottom of the display.





From left: Bits D15~D0

4. Press *Define* inputs from the bottom menu.



5. Press *Select* on the side menu and select a channel.

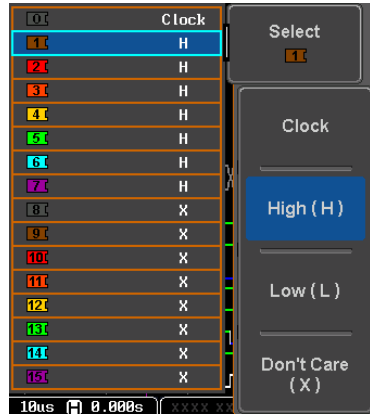

6. Next, select a logic level for the selected channel, or set the selected channel as the clock signal.

Logic Clock, High (H), Low (L), Don't Care (X)

7. Repeat steps 5 to 6 for the remaining channels.
8. The chosen logic levels will be reflected in the trigger indicator at the bottom of the screen. The color of each channel, if active will also be displayed. If a channel is not turned on, it will be grayed-out (see page 211 to turn the digital channels on or off in the Logic Analyzer menu).

Example

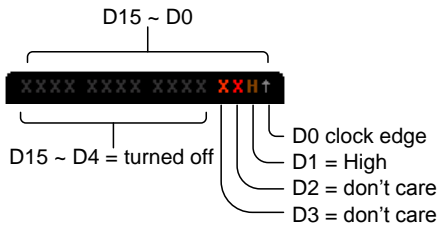

Logic Trigger  
Timing

If a channel was selected as a clock signal, then the clock edge determines when the logic comparison is made. If a clock was not defined then the *When* menu determines the triggering timing conditions. This is described below in step 9 and 10.

9. If a clock signal was defined, press *Clock Edge* from the bottom menu and select a clock transition. At each clock transition a comparison will be made.

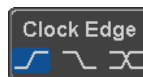

Clock Edge      Rising, Falling, Either

10. If no clock were defined, press *When* from the bottom menu and choose the trigger timing conditions.

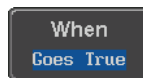

Trigger When	Description
Goes True	Triggers when the defined logic goes true (rising edge).
Goes False	Triggers when the defined logic goes false (falling edge).
Is True >	10.0ns ~ 9.99s. Triggers when the defined logic is true for greater than the defined amount of time (falling edge).
Is True <	10.0ns ~ 9.99s. Triggers when the defined logic is true for less than the defined amount of time (falling edge).
Is True =	10.0ns ~ 9.99s. Triggers when the defined logic is true for the defined amount of time $\pm 5\%$ (falling edge).

Is True  $\neq$  10.0ns ~ 9.99s. Triggers when the defined logic is not true for the defined amount of time  $\pm 5\%$  (falling edge).

11. The oscilloscope will now trigger when the specified logic appears among the digital channels.

**Trigger Threshold Levels** The trigger threshold levels for the digital channels can be assigned from a selected number of preset levels or a user-defined threshold level.



Note

The threshold levels that are set in this menu will replace the threshold levels that are set in the Logic Analyzer menu (page 217).

12. Press *Thresholds* from the bottom menu.

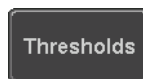

13. Press *Select* from the side menu and choose a group of channels.

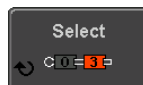

Group D0~D3, D4~D7, D8~D11, D12~D15

14. Press *Choose Preset* to select a preset logic threshold.

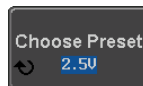

Logic Type	Threshold
TTL	1.4V
5.0V CMOS	2.5V
3.3V CMOS	1.65V
2.5V CMOS	1.25V
ECL	-1.3V
PECL	3.7V

0V

0V

15. Press *Threshold* to set a user defined threshold.

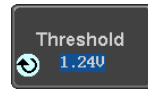

Range

 $\pm 5.00V$



# Search

The search feature can be used to search for events on the analog and digital input channels. The events that can be searched for are similar to the events that are used for the trigger system. The only difference is that the search feature uses the measurement threshold levels rather than the trigger level to determine events.

## Configuring Search Events

**Background** Similar to configuring the trigger system, the Search events must first be configured before they can be found.

Luckily the trigger system configuration settings can also be used for the search events. The types of searches are listed below. Please note that a full description of the events can be found in the Trigger section on page 151.

**Display**

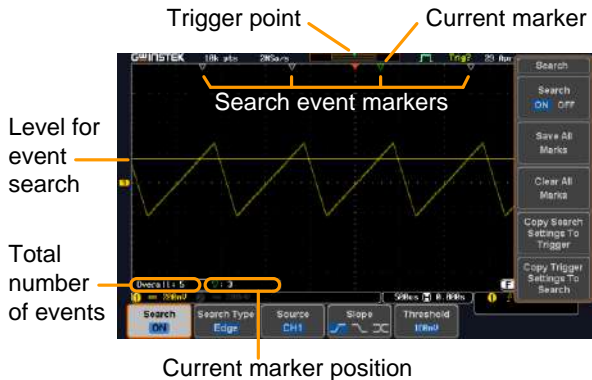

**Search Event Types** Edge, Pulse Width, Runt, Rise and Fall Time, FFT Peak\*, Logic and Bus  
 \*The FFT Peak search event doesn't have a trigger equivalent.

- Panel Operation
1. Press the *Search* menu key.
  2. Press *Search* from the bottom menu and turn the Search function on.
  3. Press *Search Type* from the bottom menu and select the type of search. The search events are configured in the same fashion as the trigger events.

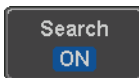

Please see the trigger configuration settings for details:

Event Types: Edge, Pulse Width, Runt, Rise/Fall Time, FFT Peak\*, Logic, Bus  
\*No trigger equivalent.

4. Select the source from which to search events. Press *Source* from the bottom menu, and select the source.



Sources: CH1 ~ CH4, Math, D0 ~ D15

5. To set the threshold levels for the search events (instead of the trigger level that is used for trigger events), use the threshold soft-key from the bottom menu.

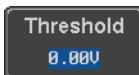

Note

The search function can support up to 10,000 events, however only 1,000 events can be displayed on screen at once.

## Copying Search Event To/From Trigger Events

---

**Background** As the trigger system and search feature have similar settings, their settings can be used interchangeably by using the Copy functions.

---

**Interchangeable Settings** Edge, Pulse Width, Pulse Runt, Rise and Fall Times, Logic and Bus (FFT Peak has no trigger equivalent)

---

**Panel Operation** 1. Press *Search* from the lower bezel menu.



2. To copy the settings of the selected search type to the trigger settings, select *Copy Search Settings to Trigger*.



3. To copy over the current trigger settings to the search settings, press *Copy Trigger Settings To Search*.

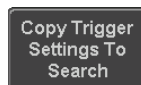

Note

If the settings cannot be copied or if there are no trigger settings configured (so that you cannot copy from the trigger settings), then those particular options will not be available.

## Search Event Navigation

---

**Background** When using the search feature, each event can be searched according to the event settings.

---

**Operation** 1. Turn Search on and set the appropriate search type.

Page 193

2. Search events are marked by hollow white triangles at the top of the graticule.
3. Use the search arrow keys to move between each search event.

Search events can be navigated in both stop and run mode.

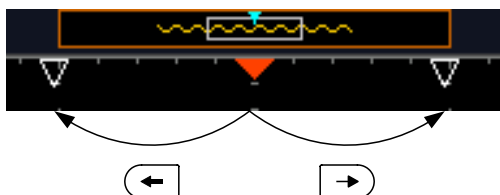

When using the arrow keys to navigate to each event, the “current event” will always be centered on the display.

## Save Search Marks

---

**Background** The search events can be saved to the graticule display, allowing you to superimpose new search events. Search events are saved over the entire record length, with a maximum of 1000 marks.

**Save Marks**

1. Press *Search* from the lower bezel menu.



2. Press the *Save All Marks* soft-key.

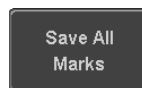

3. The search event markers will become solid white triangles to indicate that they have been saved.

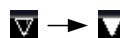

Clear All Marks

To clear all the saved marks, press  
Clear All Marks from the side  
menu.

 Clear All  
Marks

Each time the Save All Marks function is used, the  
previously saved marks will also be retained,  
unless cleared.



## Setting/Clearing Single Search Events

---

Background

In addition to searching for search events based on  
Search Type settings, custom search marks can be  
created with the Set/Clear key.

Set Search Event

1. Navigate to a point of interest using  POSITION   
the horizontal position knob or  
some other method.



 PUSH TO  
ZERO

2. Press the *Set/Clear* key.

 Set/Clear

3. A marker will be saved at the center  
of the display.

- This marker can be navigated  
to/from in the same way that a  
normally saved search marker  
can.

Clear Search Event

To clear a set search event, use the  
search arrows to navigate to the  
event of interest and press the  
Set/Clear key.

 Set/Clear

The marker will be deleted from the  
display.

## FFT Peak

**Background** The FFT Peak search type can be used to mark all FFT peaks that are above a certain threshold.

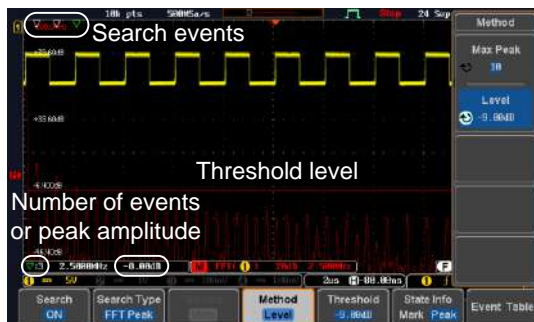

**Note**

The search function can support up to 10,000 events, however only 1,000 events can be displayed on screen at once.

**Panel Operation** 1. Turn the FFT math function on. Page 75

2. Press the *Search* menu key.



3. Press *Search* from the bottom menu and turn the Search function on.

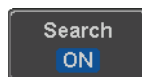

4. Press *Search Type* from the bottom menu and select *FFT Peak* from the side menu.

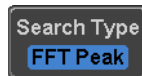

5. Note that the Math source is automatically selected.

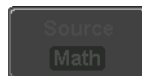

6. Next, select the event search method by pressing *Method* from the bottom menu.

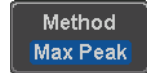

Select *Max Peak* to search by a selected number of “max” peaks.



Select *Level* to set the threshold level for the search events. Any peaks above the threshold level will be seen as a search event.

The threshold level will be mirrored in the Threshold key.



Max Peak 1 ~ 10

Level -100db ~ 100dB

View Number of Peak Events

To view the number of peak events, set *State Info* to Mark. The number of search events will be shown at the bottom of the screen.



View Amplitude of Peak Search Event

To view the position and amplitude of a selected event, set *State Info* to Peak. This information will be shown at the bottom of the display.



**Peak Event Table** The Event Table function tabulates the amplitude and frequency of each peak event in real time. The event table can also be saved to a USB disk drive. File names are saved as a PeakEventTbXXXX.csv, where XXXX is a number starting from 0001 and is incremented each time the event table is saved.

7. Press *Event Table* from the bottom menu and turn the Event Table function on.

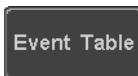

The event table will appear on the screen.

No.	Frequency	Value
1	1.0000MHz	-30.4dB
2	2.0000MHz	-31.2dB
3	3.0000MHz	-32.0dB
4	4.0000MHz	-35.2dB
5	5.0000MHz	-38.4dB
6	6.0000MHz	-44.0dB
7	7.0000MHz	-54.4dB
8	9.0000MHz	-52.0dB
9	10.0000MHz	-51.2dB
10	11.0000MHz	-52.0dB
11	12.0000MHz	-59.4dB
12	497.0000MHz	-58.4dB
13	498.0000MHz	-55.0dB
14	499.0000MHz	-54.4dB

Annotations: 'Amplitude' points to the 'Value' column; 'Peak frequency' points to the 'Frequency' column; 'Peak number' points to the 'No.' column.

- Save Event Table**
8. To save the event table, insert a USB memory drive into the front panel USB-A port.

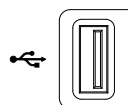

9. Press *Save Event Table*. The event table will be saved as PeakEventTbXXXX.csv.

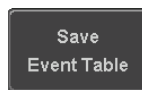



Event Table CSV Format      The format for the CSV file is the same as the event table displayed on the MSO-2000E/2000EA screen; No., Frequency, and Value.

For example:

No.	Frequency	Value
1	1.0000MHz	-29.6dB
2	2.0000MHz	-30.4dB
3	3.0000MHz	-32.0dB

---

Center Peak Results on Screen      To shift the peak events to the center of the screen, press *Selected Peak To Center* from the event table side menu.

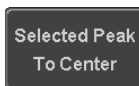

## System Settings and Miscellaneous Settings

This section describes how to set the interface, language, time/date, probe compensation signal, erase the internal memory and access useful QR codes.

### Select Menu Language

---

Description      The MSO-2000E/2000EA has a number of different languages to choose from.

---

Panel Operation    1. Press the *Utility* key.

A grey, rounded rectangular button with the word "Utility" in white text.

2. Press *Language* on the lower menu.

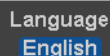
A dark grey, rounded rectangular button with a thin border. The word "Language" is at the top in white, and "English" is below it in blue.

3. Select the language\* from the side menu.

\*Language selection may differ based on region, and as such are not listed here.

## View System Information

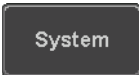
- Panel Operation
1. Press the *Utility* key. 
  2. Press *System* from the lower menu. 
  3. Press *System Info* from the side menu. A display panel will appear showing:
    - Manufacturer name
    - Model name
    - Serial number
    - Firmware version
    - Manufacturer URL

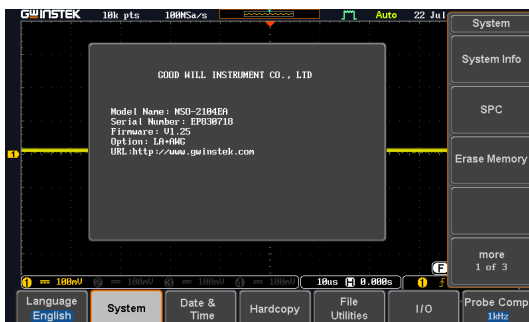

## Erase Memory

**Background**      The Erase Memory function will erase all internal waveforms, setup files and labels from internal memory.

**Erased Items**      Waveform 1~20, Setting memory 1~20, Reference 1~4, Labels

- Panel Operation
1. Press the *Utility* key. 

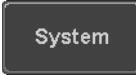
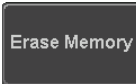
2. Press *System* from the lower menu. 
3. Press *Erase Memory* from the side menu. 

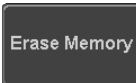

A message will prompt you to press *Erase Memory* again to confirm the process. Pressing any other key will cancel erasing the memory.

4. Press *Erase Memory* again. 

## Set Date and Time

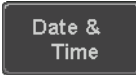
---

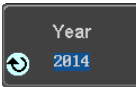
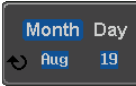
- Panel Operation/  
Parameter
1. Press the *Utility* key. 
  2. Press *Date & Time* on the lower menu. 
  3. Set the *Year*, *Month*, *Day*, *Hour* and *Minute* from the side menu.
 

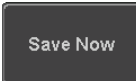
Year	2000 ~ 2037	
Month	1 ~ 12	
Day	1 ~ 31	
Hour	1~23	
Minute	0~59	
  4. Press *Save Now* from the side menu to save the date and time. 

5. Make sure the date/time setting is correctly reflected at the top of the display.



## Probe Compensation Frequency

**Background** The probe compensation output can be set from 1kHz (default) to 200kHz, in steps of 1kHz.

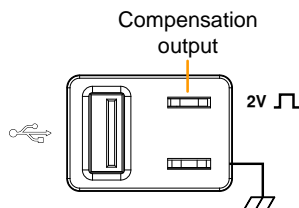

**Panel Operation/  
Parameter**

1. Press the *Utility* key.
2. Press *Probe Comp.* on the lower menu.
3. Press *Frequency* and change the frequency of the probe compensation signal.

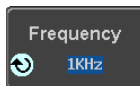

**Default Frequency**

4. Press *Default* to set the frequency of the probe compensation signal to 1kHz default.



## QR Code Reader Function

**Background**

The QR Code reader function displays a number of preset QR codes that link to useful websites.

- QR Code Items
- GW Instek website
  - GW Instek contact window (marketing department)

Panel Operation/  
Parameter

1. Press the *Utility* key.



2. Press *System* from the lower menu.

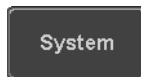

3. Press *More 1 of 3*, *More 2 of 3* from the side menu.

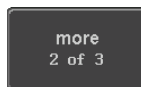
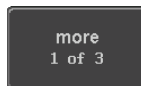

4. Press *QR Code* from the side menu. There will be two pages of QR codes to choose from.

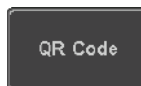

Press *Page 1* or *Page 2* to navigate to each page.



5. Use a QR code reader app on your smart phone or tablet to read one of the QR codes.

# LOGIC ANALYZER

---

Logic Analyzer Operation.....	208
Overview.....	208
Using the Logic Analyzer Probes.....	209
Digital Display Overview.....	210
Activating Digital Channels.....	211
Activate Digital Channels as a Group.....	211
Activate Individual Channels.....	212
Moving the Digital Channels or Creating Digital Channel Groups ..	213
Digital Channel Vertical Scale.....	217
Digital Channel Threshold Levels.....	217
Analog Waveform.....	219
Adding Labels to Digital Channels or the Analog Waveform.....	220

## Logic Analyzer Operation

### Overview

---

**Background**      The logic analyzer inputs can be used to measure discrete inputs or can be used to measure values on a parallel or serial bus.

The logic analyzer has a sample rate of 1GSa/s with a bandwidth of 200MHz.

---

**Supported Logic Thresholds**    TTL, CMOS, ECL, PELC, User- defined      The MSO-2000E/2000EA supports common logic thresholds and supports user-defined thresholds of  $\pm 5V$  if the in-built threshold levels are unsuitable.

---

**Digital Trigger Types**      Edge, Pulse Width, Timeout, Bus, Logic      As standard, the digital channels support basic edge, pulse width, timeout as well as bus and logic triggers.



## Using the Logic Analyzer Probes

**Background** This section will describe how to connect the digital channels to the device under test.

**Connection**

1. Turn the DUT off to protect it from being short circuited when the probes are attached.
2. Insert the Logic Analyzer probe (GTL-16E) into the Logic Analyzer slot input.

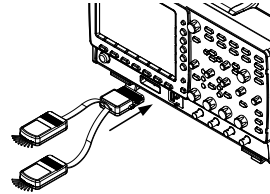

3. Connect the ground lead from the logic analyzer probe (marked G) to the circuit ground on the DUT.



4. Connect another probe lead to a point of interest on the circuit. Make note of which probe lead is connected to which point.
5. Repeat step 4 with any remaining probes.

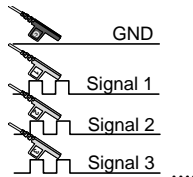

## Digital Display Overview

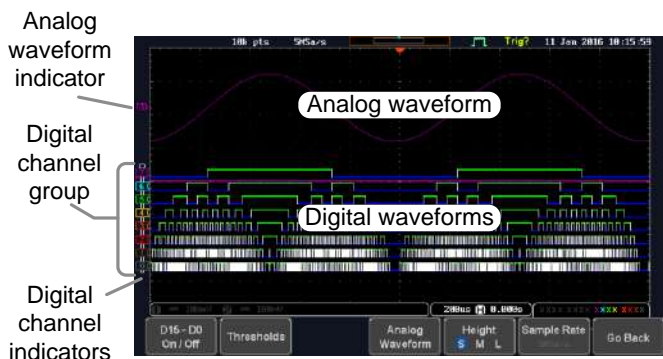

**Analog Waveform Indicator** Used to show the position of the analog waveform outputs.

- A1** Currently active analog waveform (solid indicator)
- A1** Activated analog waveform (transparent indicator)

**Digital Channel Indicators** Used to show the position and grouping of the digital channels.

- 7** Currently active digital channel (solid indicator)
- 7** Activated digital channel (transparent indicator)

**Digital Channel Group (Pinned)** When digital channels are grouped together, they are shown as being pinned together. When grouped, digital channels can be moved as a single group.





## Activating Digital Channels

The digital channels can be initially turned on in groups of 8 or individually.

### Activate Digital Channels as a Group

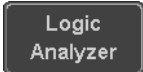
**Background**      The digital channels can be turned on or off in groups of eight, D0~D7 and D8~D15.

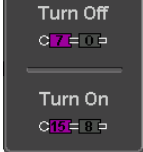
- |                        |   |   |
|------------------------|---|---|
| <b>Panel Operation</b> | <ol style="list-style-type: none"> <li>1. Press the <i>Option</i> key.</li> <li>2. Press <i>Logic Analyzer</i> from the bottom menu.</li> <li>3. Press D15 - D0 On/Off key.</li> <li>4. Select which group of digital inputs you want turned on or off from the side menu.</li> </ol> | <p>Option</p> <br><br><br><br><br><br> |
|                        | <p>Group1    D0~D7</p> <p>Group2    D8~D15</p>  |   |
|                        | <ol style="list-style-type: none"> <li>5. The digital channels will appear on the graticule.</li> </ol>   |   |

 **Note**

When all the digital channels are turned on, they will appear as a single group.

## Activate Individual Channels

**Background** Each digital channel or group can be turned on or off individually.

**Panel Operation** 1. Press the *Select* soft-key.

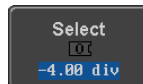

2. Use the variable knob to highlight a channel or a group.

VARIABLE

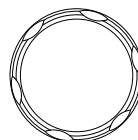

3. A 'tick' next to a particular channel or group indicates that the channel or group is currently on.



4. Press the *Display* soft-key or the *Select* key to toggle the selected channel or group on or off.

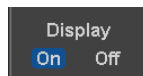

or

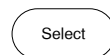

5. Press the *Select* soft-key again to reduce the menu.

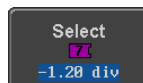



Note

Channels can also be selected just by turning the variable knob when the mode is set to LA move mode. In this mode the selected channel or group will be shown on the Select soft-key. However this method will only show those channels/groups that have already been turned on. See below for details.

## Moving the Digital Channels or Creating Digital Channel Groups

---



Note

The digital channels must first be activated. See page 211.

### Background

The logic analyzer has two basic modes of operation for selecting or moving digital channels.

LA Select mode: This mode is used to select digital channels that have already been activated.

LA Move mode: This mode is used to move the vertical position of the digital channels and to group digital channels into groups.

The Select key is used to toggle between both modes when in the *D15~D0 On/Off* menu.

### Panel Operation

1. Press the D15~D0 On/Off key. The scope will initially be in 'LA Select mode'.



2. Use the variable knob to choose a channel or group. The selected channel/group will be shown on the Select key. Only channels that have been activated can be selected this way.

VARIABLE

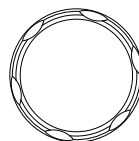

Below, channel 4 is selected.

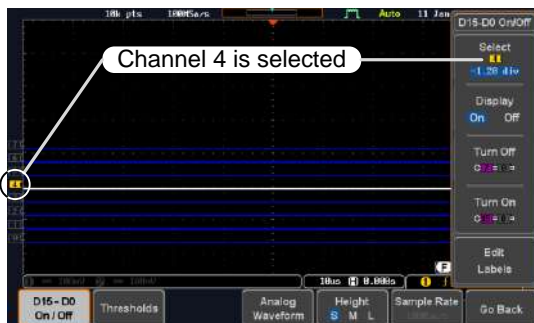

Note: If the Variable knob cannot select a channel, press the Select key to toggle the scope into 'LA Select mode'.

3. Press the *Select* key. The mode toggles from 'LA Select mode' to 'LA Move mode'.



A message will indicate which mode is currently active.

The Move mode is used to move the digital channel position on the graticule as well as to group the channels. If you turned on all the digital channels, you will notice that they are already grouped as a single group.

You can tell when it is in move mode as the selected channel/group flashes and the labels for the other channels/groups become grayed out.

Channel 4 is in the 'Move' mode and the labels for the other channels are grayed out



- Use the variable knob to position the selected channel/group:

VARIABLE

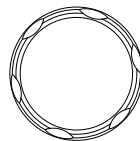

If you position the channel indicator over the next/previous channel, it will split the group into 2.

Split the group above the selected channel:

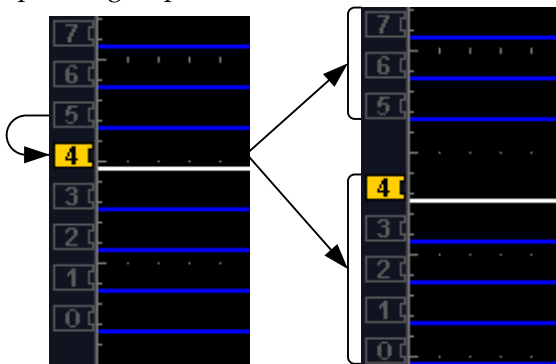

Split the group below the selected channel:

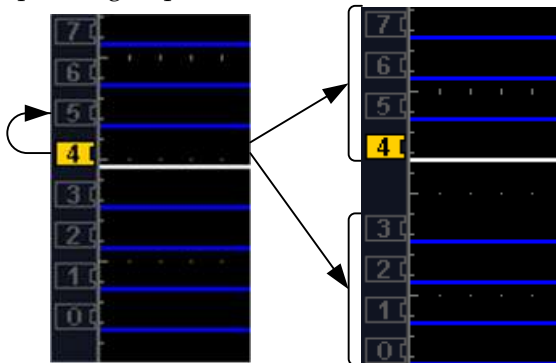

If you continue to move the channel indicator past the next/previous channel, it will move the indicator anywhere within that group.

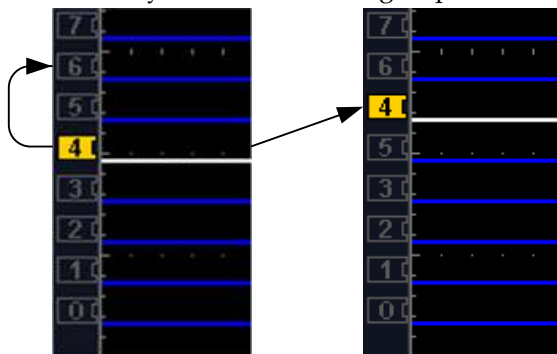

5. If you move the indicator *outside* of the group, it will remove the selected channel from the group.



6. Press the *Select* key again. This will return you to the LA Select mode.

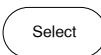

You can tell when it is in the Select mode as no channel will be grayed out.



## Digital Channel Vertical Scale

---

**Background**      The digital channels have 3 preset scales, S, M, L.

---

**Panel Operation**    1. From the bottom menu, press *Height* to toggle the vertical scale of the digital channels.



Height      S, M, L

---



If more than 8 digital channels are active, the large (L) option will be disabled.

## Digital Channel Threshold Levels

---



Threshold levels can be set to four groups of digital channels: D0~D3, D4~7, D8~D11 and D12~D15. Each group can have a different threshold level.

The MSO-2000E/2000EA has 7 preset threshold levels and a user-defined threshold. A user-defined threshold level can be set for each group. Any signal over the threshold level corresponds to a high (1); any signal under the threshold level is a low (0).

---

**Panel Operation**    1. From the bottom menu, press the *Thresholds* soft-key.

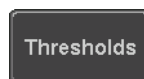

2. Press *Select* from the side menu and choose a group of channels.

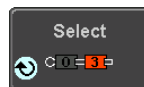

3. Press *Choose Preset* to select a pre-set logic threshold.

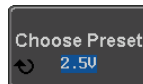

Logic Type	Threshold
TTL	1.4V
5.0V CMOS	2.5V
3.3V CMOS	1.65V
2.5V CMOS	1.25V
ECL	-1.3V
PECL	3.7V
0V	0V

4. Press *Threshold* to set a user defined threshold for the currently selected group.

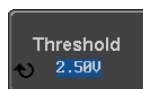



Range            ±5V

## Analog Waveform

**Background** The analog waveform function combines the digital channel inputs into two 8-bit analog waveforms. The analog waveforms are created from the digital channel groups D0~7 and D8~15.

### Example

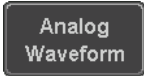
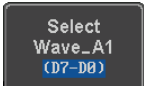
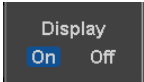

- |                              |  |   |
|------------------------------|--|---|
| <b>Panel Operation</b>       | <ol style="list-style-type: none"> <li>1. Press the <i>Option</i> key.</li> </ol>  | <p>Option</p>  |
|                              | <ol style="list-style-type: none"> <li>2. Press the Analog Waveform key.</li> </ol>  |               |
|                              | <ol style="list-style-type: none"> <li>3. Press <i>Select</i> and choose between Wave_A1 (D7~D0) or Wave_A2 (D15~D8).</li> </ol>                                     |              |
| <b>Display on Screen</b>     | <ol style="list-style-type: none"> <li>4. Press <i>Display</i> to display the selected waveforms on the screen.</li> </ol>   |              |
| <b>Set Vertical Position</b> | <ol style="list-style-type: none"> <li>5. Press <i>Vertical</i> until the div parameter is highlighted. Use the <i>Variable</i> knob to set the position.</li> </ol> |              |

Set Vertical Scale 6. Press Vertical until the X scale parameter is highlighted. Use the *Variable* knob to set the scale.

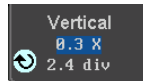

Edit Labels 7. Press Edit Labels to edit the label for the currently selected analog waveform. See below for details.

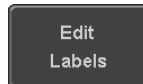

Note

Only one analog waveform can be displayed at a time.

## Adding Labels to Digital Channels or the Analog Waveform

Background Digital labels can be added to each digital channel or to one of the analog waveforms.

Panel Operation 1. To edit labels for the digital channels, press the *Edit Labels* soft-key from the *D15~D0 On/Off* menu.

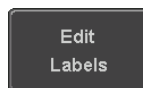

To edit labels for the analog waveforms, press the *Edit Labels* soft-key from the *Analog Waveform* menu.

2. Press *Label For* and select a digital channel. An analog waveform cannot be chosen. The currently active analog waveform will be displayed for reference.



Label For D0~D15  
A1, A2

3. To choose a preset label, Press *User Preset* from the side menu and choose a label.



Labels ACK, AD0, ADDR, ANALOG, BIT, CAS, CLK, CLOCK, CLR, COUNT, DATA, DTACK, ENABLE, HALT, INT, IN, IRQ, LATCH, LOAD, NMI

Edit Label

4. Press *Edit Character* to edit the current label.

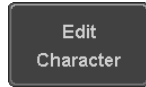

5. The Edit Label window appears.

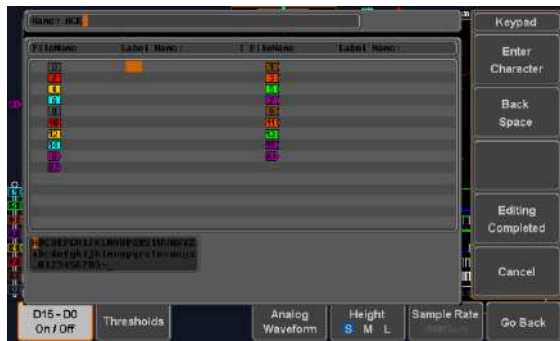

6. Use the Variable knob to highlight a character.

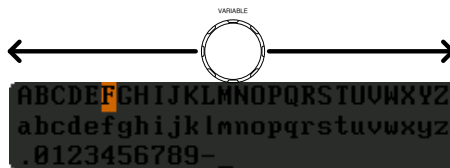

Press *Enter Character* to select a number or letter.

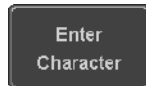

Press *Back Space* to delete a character.

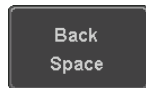

Press *Editing Completed* to create the new label and return to the previous menu.

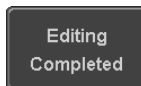

Note: this key must be pressed to create a label, even for a preset label.

Press *Cancel* to cancel the editing and return to the Edit Label menu.

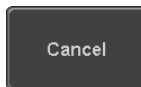

- The label will appear next to corresponding channel indicator.

Below, the label "LABEL\_7" was created for the D7 channel.



Remove Label

Press *Label Display* to toggle the selected label on or off.

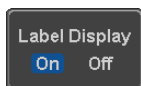

# ARBITRARY WAVE GENERATOR

---

Arbitrary Wave Generator Operation ..	224
Overview .....	224
Rear Panel .....	225
AWG Display Overview .....	226
Generator Connection .....	226
Output Setup .....	227
Select the Active Channel .....	227
Turn the Output On for the Selected Channel .....	228
Setting the Load Impedance .....	228
Setting the Phase .....	228
GEN1 and GEN2 Setup .....	229
Selecting a Waveform .....	229
Waveform Settings .....	230
AM Modulation .....	233
FM Modulation .....	235
FSK Modulation .....	237
Sweep .....	239
Manage Arbitrary Waveforms .....	241
Create New ARB Waveform .....	241
Edit an Existing ARB Waveform .....	243
Load ARB Waveform .....	250
Save ARB Waveform .....	252
Coupling and tracking waveforms settings .....	254

# Arbitrary Wave Generator Operation

## Overview

---

Background	The AWG is a full-function dual channel arbitrary waveform generator. It is available on the MSO-2000EA only.
------------	---

---

Waveforms	Arbitrary, Sine, Square, Pulse, Ramp, DC, Noise, Sinc, Gaussian, Lorentz, Exp. Rise, Exp. Fall, Haversine, Cardiac
-----------	--

---

Functions	AM, FM, FSK, Sweep
-----------	--------------------



## Rear Panel

---

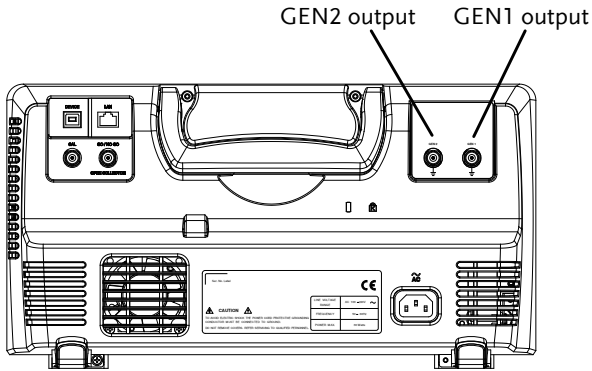

GEN1 and GEN2  
Output

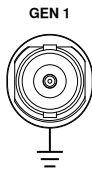

Outputs for the Generator 1 or  
Generator 2 signals.

## AWG Display Overview

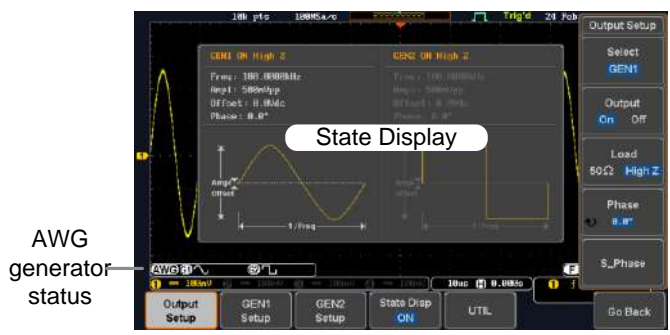

**State Display** The state display is used to visually show the major channel settings when you are in the AWG menu.

**AWG Generator Status Indicators** The AWG channel status indicators show the active channels, output waveforms and function.

**AWG** AWG status indicator

**G1** Channel status indicator (G1, G2)

**Waveform icon** Waveform indicator of the indicated channel (Sine, arbitrary, pulse etc...).

**+AM** Function indicator for the indicated channel (AM, FM, SWP).

## Generator Connection

**Background** This section will explain how to connect a DUT to the channel outputs.

- Connection
1. Connect the BNC output (GEN1 or GEN2) to the DUT using the GTL-101 BNC-Alligator clip cables.

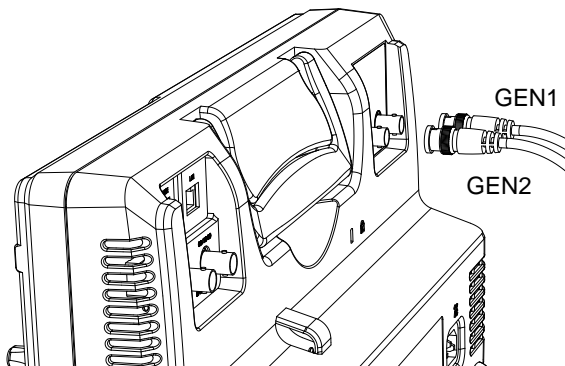

## Output Setup



---

The Output Setup menu allows you to select a channel, to turn the output on or off for the selected channel, configure the load impedance and the phase of the output.

### Select the Active Channel

---

**Background** Before any operations can be performed on a channel it must first be selected.

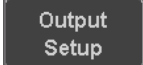
- Panel Operation**
1. Press the *Option* key.
 
  2. Press *AWG* from the bottom menu.
 
  3. Press *Output Setup*.
 

4. Press *Select* from the side menu and choose GEN1 or GEN2.



### Turn the Output On for the Selected Channel

---

**Background**      The output for each generator channel can be turned on or off independently.

---

- Panel Operation**    1. Press *Output* to toggle the selected channel on or off.

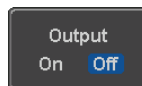

### Setting the Load Impedance

---

**Background**      The load impedance can be independently set for each generator channel.

---

- Panel Operation**    1. Press *Load* to toggle the impedance between 50Ω and High Z.



### Setting the Phase

---

**Background**      The output phase can only be set for the GEN1 output. GEN2 is always set to an output phase of 0°.

---

- Panel Operation**    1. Press *Phase* and use the variable knob to set the phase.



Phase      -180° ~ 180°

---

- Reset Phase**      2. The phase can be reset by pressing *S\_Phase*.

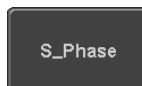

## GEN1 and GEN2 Setup

---

The GEN1 Setup and GEN2 Setup select the output waveform, waveform settings (amplitude, frequency, offset), modulation mode or allow you to create arbitrary waveforms.

### Selecting a Waveform

---

**Background** The AWG option has 14 selectable waveforms, including a user-created arbitrary waveform. When using the modulation function, the waveform selected here is also used as the carrier wave.

- Panel Operation**
1. From the AWG menu press *GEN1 Setup* or *GEN2 Setup* to select the waveform for generator 1 or generator 2, respectively.
  2. Press *Waveform* from the bottom menu.
  3. From the side menu press the waveform soft-key and select a waveform using the variable knob.



OR

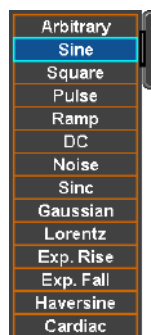

Selectable waveforms Arbitrary, sine, square, pulse, ramp, DC, Noise, Sinc, Gaussian, Lorentz, Exp. Rise, Exp. Fall, Haversine, Cardiac.

## Waveform Settings

---

**Background** The Waveform Settings sub menu selects the Frequency, amplitude and offset settings for currently selected waveform in the GEN1 or GEN2 Setup menu.

1. From the Waveform menu, press *Waveform Settings* from the side menu.

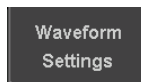

- Set the Frequency
2. Press *Frequency* to set the frequency rate of the waveform.

Note: When *Frequency* is initially pressed the variable knob can be used to quick-select the frequency step-resolution. The variable knob can then be used to set the frequency in increments of the step resolution.

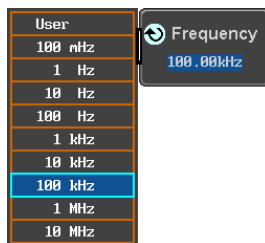

Range 100mHz ~ 25MHz

- Set the Amplitude
3. Press *Amplitude* to set the amplitude of the waveform.





- Use the Left and Right arrow keys to select a base unit and use the variable knob to increase the amplitude by that base unit, as shown in the Amplitude window.

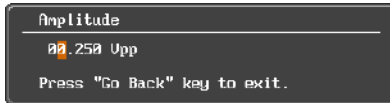

- Default can be pressed to set the amplitude to 1.00Vpp.
- Press Go Back to leave the menu.

Range	10mVpp to 2.5Vpp (Load:50Ω) 20mVpp to 5Vpp (Load: High Z)
Default	1.00Vpp

Set the Offset

- Press *Offset* to set the offset of the waveform.



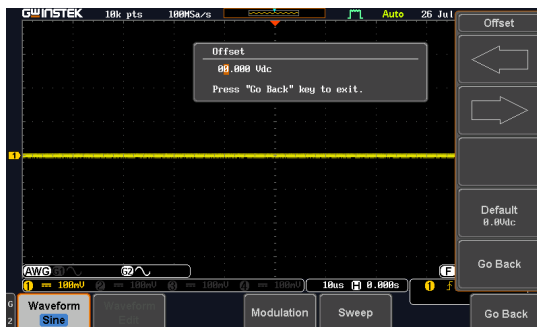

- Use the Left and Right arrow keys to select a base unit and use the variable knob to increase the offset by that base unit, as shown in the Offset window.



- Default can be pressed to set the Offset to 0.00Vdc.
- Press Go Back to leave the menu.

Range	$\pm 1.25\text{Vdc}$ (Load: $50\Omega$ )
	$\pm 2.5\text{Vdc}$ (Load: High Z)
Default	0.00Vdc

Exit Waveform Settings

- Press *Go Back* to exit the waveform settings.

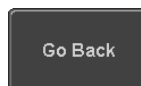



## AM Modulation

**Background** Amplitude modulation can be used for either channel. All waveforms except Noise and DC can be used as the carrier wave. Sine, square, pulse, ramp and noise can be selected as the modulating waveform.

### Example

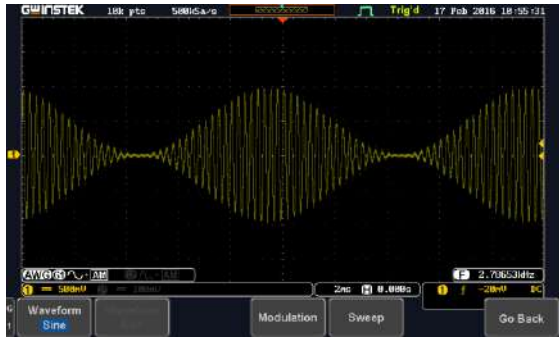

- Panel Operation** 1. Select the carrier waveform from the GEN1 Setup/GEN2 Setup menu:

Press *GEN1 Setup* or *GEN2 Setup* for generator 1 or generator 2, respectively.









Press *Waveform* from the bottom menu.

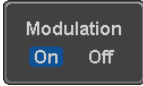

Select the waveform from the side menu. This will be the carrier wave.

**Carrier Waves** Sine, square, pulse, ramp, sinc, gaussian, Lorentz, exp. rise, exp. fall, haversine, cardiac.

	2. Press the <i>Modulation</i> from the bottom menu.	
	3. From the side menu, turn <i>Modulation</i> on.	
	4. Press <i>AM</i> to select AM modulation and to enter the AM modulation setup menu.	
Set the Modulation Depth	5. Press <i>Depth</i> to set the modulation depth.	
	Depth                      0.0% ~ 120.0%	
Modulation Frequency	6. Press <i>AM Freq</i> to set the modulation frequency.	
	Frequency                200kHz ~ 1Hz	
Shape	7. Press <i>Shape</i> to set the modulating wave shape.	
	Shape                      Sine, square, pulse, ramp, noise	
Phase (Sine wave only)	8. Press <i>Phase</i> to set the phase of the modulated wave (sine wave).	
	Phase                      -180.0° ~ 180.0°	
Duty Cycle (Pulse wave only)	9. Press <i>Duty Cycle</i> to set the duty cycle (pulse wave).	
	Duty Cycle                1.0% ~ 99.0%	

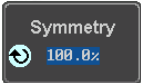
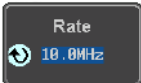
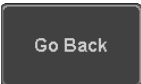
- |                                 |   |   |
|---------------------------------|---|---|
| Symmetry<br>(Ramp wave only)    | 10. Press <i>Symmetry</i> to set the symmetry (pulse wave). |  |
| Symmetry      0% ~ 100%         |   |   |
| Rate<br>(Noise wave only)       | 11. Press <i>Rate</i> to set the rate (noise wave).         |  |
| Noise              1kHz ~ 10MHz |   |   |
| Exit AM Settings                | 12. Press <i>Go Back</i> to exit the AM settings.           |  |

## FM Modulation

**Background**      Frequency modulation can be used for either channel. The carrier wave can only be sine, square and ramp waveforms. Sine, square, pulse, ramp and noise can be selected as the modulating waveform.

### Example

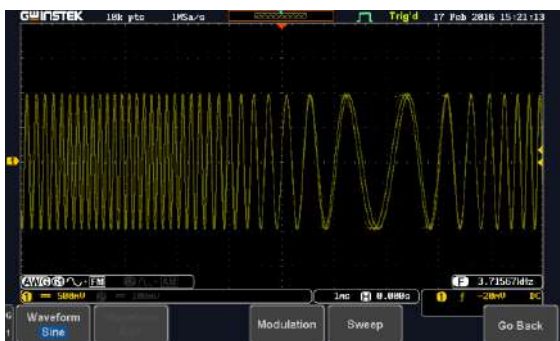

- Panel Operation**    1. Select the carrier waveform from the GEN1 Setup/GEN2 Setup menu:

Press *GEN1 Setup* or *GEN2 Setup* for generator 1 or generator 2, respectively.



Press *Waveform* from the bottom menu.



Select the waveform from the side menu. This will be the carrier wave.

Carrier Waves Sine, square, ramp

2. Press the *Modulation* from the bottom menu.

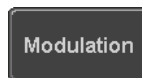

3. From the side menu, turn *Modulation* on.

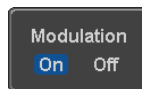

4. Press *FM* to select FM modulation and to enter the FM modulation setup menu.



Set the Frequency Deviation 5. Press *Freq Dev* to set the frequency deviation.

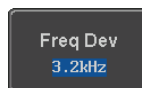

Deviation 12.5MHz ~ 0.1Hz

Modulation Frequency 6. Press *FM Freq* to set the modulation frequency.

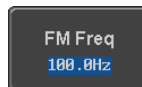

Frequency 200kHz ~ 1Hz

Shape 7. Press *Shape* to set the modulating wave shape.

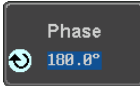
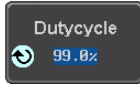
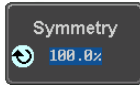
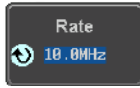
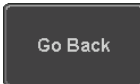

Shape Sine, square, pulse, ramp, noise

Phase (Sine wave only)	8. Press <i>Phase</i> to set the phase of the modulated wave (sine wave).	
	Phase                    -180.0° ~ 180.0°	
Duty Cycle (Pulse wave only)	9. Press <i>Duty Cycle</i> to set the duty cycle (pulse wave).	
	Duty Cycle            1.0% ~ 99.0%	
Symmetry (Ramp wave only)	10. Press <i>Symmetry</i> to set the symmetry (ramp wave).	
	Symmetry            0% ~ 100%	
Rate (Noise wave only)	11. Press <i>Rate</i> to set the rate (noise wave).	
	Noise                    1kHz ~ 10MHz	
Exit FM Settings	12. Press <i>Go Back</i> to exit the FM settings.	

## FSK Modulation

---

Background	Frequency shift keying modulation can be used for either channel. The carrier wave is limited to sine, square and ramp waveforms. Sine, square, pulse, ramp and noise can be selected as the modulating waveform.
------------	---

---

Example

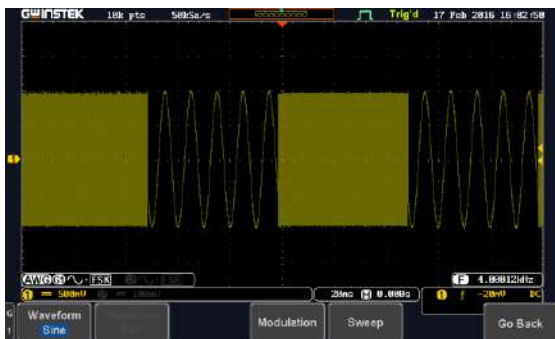

- Panel Operation
1. Select the carrier waveform from the GEN1 Setup/GEN2 Setup menu:

Press *GEN1 Setup* or *GEN2 Setup* for generator 1 or generator 2, respectively.



Press *Waveform* from the bottom menu.



Select the waveform from the side menu. This will be the carrier wave.

Carrier Waves Sine, square, ramp

2. Press the *Modulation* from the bottom menu.

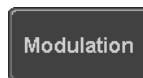

3. From the side menu, turn *Modulation* on.

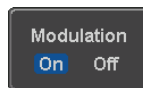

4. Press *FSK* to select FSK modulation and to enter the FSK modulation setup menu.



- |                   |   |   |
|-------------------|---|---|
| Set the Hop Freq  | 5. Press <i>Hop Freq</i> to set the hop frequency.  | <div style="border: 1px solid black; padding: 5px; display: inline-block;">Hop Freq<br/>100.0Hz</div> |
|                   | Hop Freq      25MHz ~ 0.1Hz   |   |
| FSK Rate          | 6. Press <i>FSK Rate</i> to set the rate at which the waveform switches from the carrier and hop frequency. | <div style="border: 1px solid black; padding: 5px; display: inline-block;">FSK Rate<br/>10.0Hz</div>  |
|                   | FSK Rate      1Hz ~ 200kHz  |   |
| Exit FSK Settings | 7. Press <i>Go Back</i> to exit the FSK settings.   | <div style="border: 1px solid black; padding: 5px; display: inline-block;">Go Back</div>              |

## Sweep

**Background**      The Sweep function can be used with sine, square and ramp waveforms for either channel. The function supports linear or logarithmic sweeping as well as up or down sweeping.

### Example

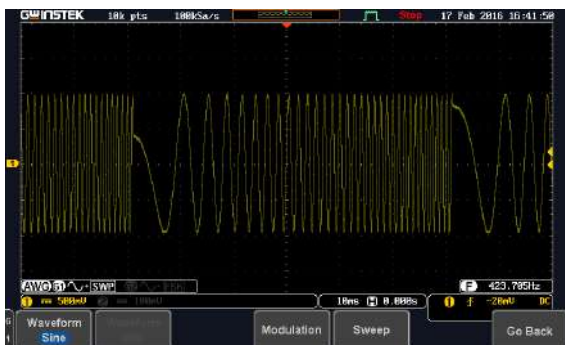

- Panel Operation**    1. Select the waveform from the GEN1 Setup/GEN2 Setup menu:

Press *GEN1 Setup* or *GEN2 Setup* for generator 1 or generator 2, respectively.



Press *Waveform* from the bottom menu.



Select the waveform from the side menu.

Sweep Waves Sine, square, ramp.

2. Press the *Sweep* from the bottom menu.

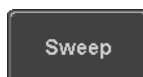

3. From the side menu, turn *Sweep* on.

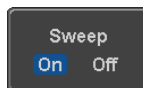

Type of Sweep

4. Press *Type* to set the sweep to linear or logarithmic.

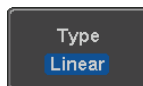

Type Linear, Log

Start and Stop Frequency

5. Press the *Start* or *Stop* soft-keys to set the start and stop frequency, respectively.

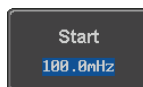

Start/Stop 25MHz ~ 0.1Hz



Note

To configure a up sweeping, set the start frequency at a lower value than the stop frequency. To configure a down sweeping, set the start frequency at a higher value than the stop frequency.

Center Frequency & Span

Alternatively the center frequency and span can be set instead of the start and stop frequencies.



6. Press *More 1 of 2*.

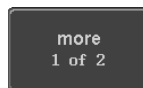

7. Press *Span* to set the frequency span of the sweep.



8. Press *Center* to set the center frequency for the configured span.

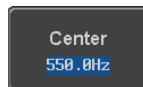

Span            25MHz ~ -25MHz  
 Center        25MHz ~ 0.1Hz



Note

To configure a up sweeping, set the span with a positive frequency. To configure a down sweeping, set the span with a negative frequency.

Sweep Time

9. Press SWP Time to set how long the sweep takes to go from the start to the stop frequency.



Sweep time    5.0us ~ 10s

## Manage Arbitrary Waveforms

The Arbitrary Waveform menus allow you to create, edit, recall and save arbitrary waveforms. The menus are accessible via the *Waveform Edit* button on the bottom menu once GEN1 or GEN2 has been setup with an arbitrary waveform.

### Create New ARB Waveform

Background

The Create New menu is used to load an inbuilt waveform with a defined length in order to build the shape of the arbitrary waveform. Supported waveforms include: Sine, Square, Pulse, Ramp and Noise.

Example

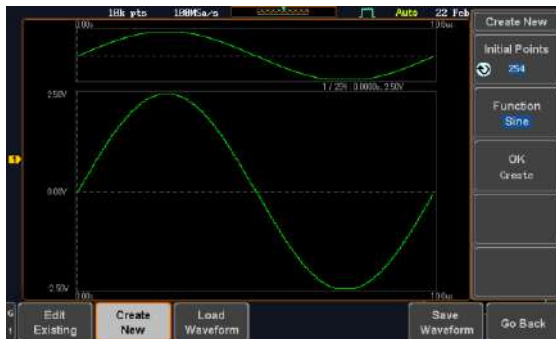

- Panel Operation
1. Select an arbitrary waveform from the GEN1 Setup/GEN2 Setup menu:

Press *GEN1 Setup* or *GEN2 Setup* for generator 1 or generator 2, respectively.



Press *Waveform* from the bottom menu.



Select *Arbitrary* from the side menu.

2. Press the *Waveform Edit* from the bottom menu.



3. From the bottom menu select *Create New*.

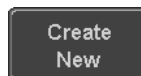

4. Press *Initial Points* to set the number of points for the waveform length.

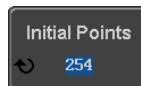

Initial Points 2 ~ 16384

5. Press *Function* to choose an inbuilt waveform :

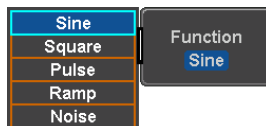

Function: Sine, Square, Pulse, Ramp, Noise

6. Press *OK Create* to create the arbitrary waveform shape.

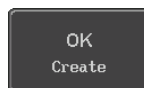

## Edit an Existing ARB Waveform

---

**Background** Use the Edit Existing menu to edit a newly created waveform and further shape it according to your requirements. You can also use the Edit Existing menu for arbitrary waveforms that have been recalled (see Load Waveform page 250). There are two main options that can be used to edit waveforms: Normal Edit and Function Edit.

### Editing Methods

#### Normal Edit:

The Normal Edit function allows you to insert or delete points at any position on a waveform.

#### Function Edit:

The Function Edit function allows you to edit the waveforms in a number of different ways:

- **Point/Line:** Insert a point or horizontal line into the ARB waveform.
- **Diagonal:** Insert a diagonal line
- **Scale:** Scales the ARB waveform vertically.
- **Copy/Paste:** Copy or paste a section of the ARB waveform.
- **Clear:** Clears a section of the ARB waveform and replaces it with a 0V DC waveform.

Example

This box shows the editing window in relation to the full ARB waveform

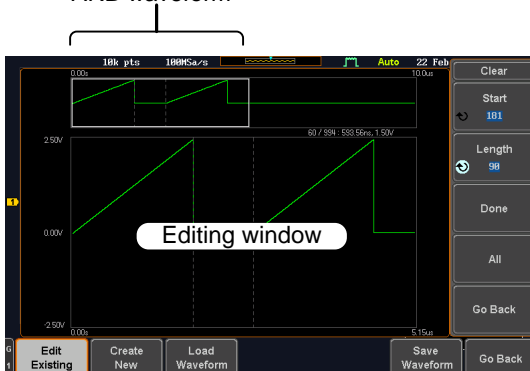

- Panel Operation
1. Select a waveform from the GEN1 Setup/GEN2 Setup menu:

Press *GEN1 Setup* or *GEN2 Setup* for generator 1 or generator 2, respectively.



Press *Waveform* from the bottom menu.

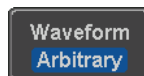

Select *Arbitrary* from the side menu.

2. Press the *Waveform Edit* from the bottom menu.



Edit Existing

3. From the bottom menu select *Edit Existing*.

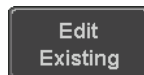

This will allow you to edit the ARB waveform that is currently loaded in memory. If no waveform has been loaded, a DC waveform is shown.

Normal Edit

4. Press *Normal Edit* to insert a point or delete a point from the waveform:



 Normal Edit

---

 Insert Point:

To insert a point, you must first set the position of the point to be inserted.

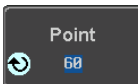
- a. Press *Point* to set the x-axis position of the point.

 Point  
60

Point      1 ~ user-defined point position

- b. Press *Level* to set the amplitude of the point. The max/min amplitude depends on the waveform amplitude settings, see page 230.

 Level  
1.00V

Level       $\pm 1.25\text{Vdc}$  (Load: 50 $\Omega$ )  
 $\pm 2.5\text{Vdc}$  (Load: High Z)

- c. Press *Insert Point*. The inserted point will increase the length of the waveform by one point.

 Insert Point

---

 Delete Point:

- d. Press *Delete Point* to delete the point set with the "Point" soft-key.

 Delete Point

The overall length of the waveform will be shortened by one point.

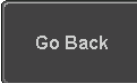
Exit Normal Edit 5. Press *Go Back* to exit the Normal Edit. 

Function Edit 6. Press *Function Edit* to perform more advanced editing functions. 

7. Press *Edit Method* to choose the editing method: 

Edit Method: Point/Line  
 Diagonal  
 Scale  
 Copy/Paste  
 Clear

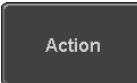
8. Press *Action* to begin using the selected editing method: 

Point/Line:

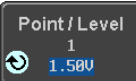
a. Press *Point/Level* once to select the point's X-axis start point. 

Press *Point/Level* again to select the amplitude (Level)

Point 1 ~ user-defined point position  
 Level ±1.25Vdc (Load: 50Ω)  
 ±2.5Vdc (Load: High Z)

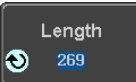
b. Press *Length* to set the length of the line. 

Length 0 ~ user-defined point length

- c. The *Adjustment* soft-key can be used to toggle the step resolution of the variable knob when editing values in this menu.

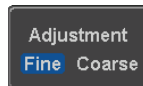

Adjustment                      Fine, Coarse

- d. Press *Preview*. The desired edit will then be previewed on the screen.

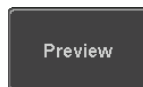

- e. Press *Done* to confirm the edit, or press *Undo* to cancel.

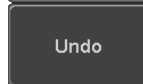
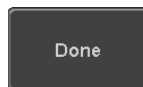

- f. Press *Go Back* to go back to the previous menu.

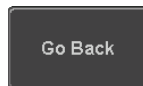

Diagonal:

- a. Press *Point1/Level1* once to select the point's X axis start point.



Press *Point1/Level1* again to select the amplitude (Level) of the start point.

Point1                      1 ~ user-defined point position

Level1                     ±1.25Vdc (Load: 50Ω)  
                                  ±2.5Vdc (Load: High Z)

- b. Press *Point2/Level2* once to select the point's X axis end point.

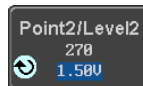

Press *Point2/Level2* again to select the amplitude (Level) of the end point.

Point2      1 ~ user-defined point position  
 Level2      ±1.25Vdc (Load: 50Ω)  
                  ±2.5Vdc (Load: High Z)

- c. The *Adjustment* soft-key can be used to toggle the step resolution of the variable knob when editing values in this menu.

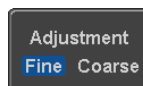

Adjustment      Fine, Coarse

- d. Press *Preview*. The desired edit will then be previewed on the screen.

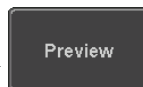

- e. Press *Done* to confirm the edit, or press *Undo* to cancel.

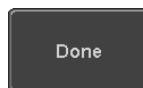

- f. Press *Go Back* to go back to the previous menu.

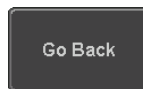

Scale:

- a. Press *Scale* and use the variable knob to set the scale of the waveform vertically.



Note: If the waveform exceeds the maximum amplitude it will be clipped.



Scale 0.1x ~ 10X

- b. Press *Go Back* to go back to the previous menu.

A dark grey rectangular button with rounded corners. The text "Go Back" is centered in white.

Copy/Paste:

---

- a. Press *Start* to set the start point of the section you want to copy.

A dark grey rectangular button with rounded corners. It features a circular arrow icon on the left. The text "Start" is at the top, and the number "1" is at the bottom, both in white.

- b. Press *Length* to set the size of the section you want to copy from the start point.

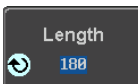
A dark grey rectangular button with rounded corners. It features a circular arrow icon on the left. The text "Length" is at the top, and the number "180" is at the bottom, both in white.

The copied section will be shown as a grey box on the display

Start 1 ~ user-defined point position

Length 1 ~ user defined point length

- c. Press *Paste To* to choose where the selected section is copied to.

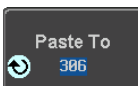
A dark grey rectangular button with rounded corners. It features a circular arrow icon on the left. The text "Paste To" is at the top, and the number "306" is at the bottom, both in white.

Paste To 1 ~ user defined point position

- d. Press *Preview*. The desired edit will then be previewed on the screen. The pasted section will be shown as a yellow box on the screen.

A dark grey rectangular button with rounded corners. The text "Preview" is centered in white.

- e. Press *Done* to confirm the edit, or press *Undo* to cancel.

A dark grey rectangular button with rounded corners. The text "Done" is centered in white.

- f. Press *Go Back* to go back to the previous menu.

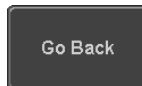

Clear Section:

---

- a. Press *Start* to set the start point of the section you want to clear.



Press *Length* to set the size of the section you want to clear.

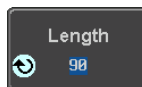

Start      1 ~ user-defined point position

Length     1 ~ user-defined point length

- b. Press *Done* to clear the selected section.

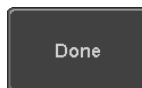

- c. Alternatively, press *All* to clear the entire waveform from the screen.



- d. Press *Go Back* to go back to the previous menu.

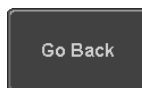

Load ARB Waveform

---

Background      ARB waveforms can be loaded from internal memory or from an external USB storage.

---

- Panel Operation    1. Select a waveform from the GEN1 Setup/GEN2 Setup menu:

Press *GEN1 Setup* or *GEN2 Setup* for generator 1 or generator 2, respectively.



Press *Waveform* from the bottom menu.

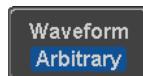

Select *Arbitrary* from the side menu.

2. Press *Waveform Edit* from the bottom menu.



3. From the bottom menu select *Load Waveform*.



4. To load a file from one of the internal memory slots, press *From* to choose the ARB waveform to load:

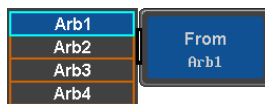

ARB: Arb1, Arb2, Arb3, Arb4

5. To load a file from an external USB or from the internal flash memory, press *From File*.

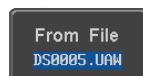

The last file that was saved to USB or the internal flash memory will be displayed in the icon.

6. To recall the displayed file, press *Recall Now*.

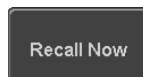

7. Alternatively, press *File Utilities*.

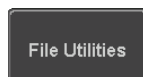

Use the Variable knob to select the desired ARB waveform.

Press the *Select* key to load the selected ARB waveform in the file utilities screen.



Note

Press *File Utilities* to manage the files on the internal disk or an inserted USB disk. See page 308 for details.

## Save ARB Waveform

**Background** ARB waveforms can be saved to internal memory or to an external USB storage.

**Panel Operation** 1. Select a waveform from the GEN1 Setup/GEN2 Setup menu:

Press *GEN1 Setup* or *GEN2 Setup* for generator 1 or generator 2, respectively.



Press *Waveform* from the bottom menu.



Select *Arbitrary* from the side menu.

2. Press *Waveform Edit* from the bottom menu.



3. From the bottom menu select *Save Waveform*.



4. To save to one of the internal memory slots, press *To* to choose the ARB waveform to save:

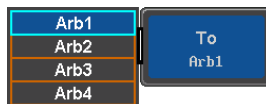

ARB: Arb1, Arb2, Arb3, Arb4

Press *Save* to save the waveform to the selected memory slot, Arb1, Arb2, Arb3 or Arb4.

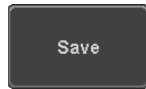

- Alternatively, to save to a USB drive or to the internal flash memory, press *To File*.

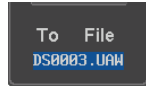

- To save the selected file, press *Save* waveform.

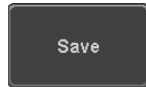

- You will automatically be taken to a file utility where you will be able to edit the name of the file.

- To edit the file name, use the *Variable* knob to highlight a character.



Press *Enter Character* or the *Select* key to select a number or letter.

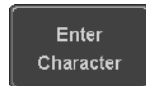

Press *Back Space* to delete a character.



- Press *Save Now* to save the file.



Note: Pressing *Cancel* will cancel the save operation and return you to the Save Waveform menu.

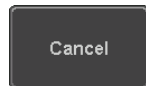

After *Save Now* has been pressed the file will be saved.

**Waveform saved to USB :/DS0003.UAW.**



Note

The file will not be saved if the power is turned off or the USB drive is taken out before the message ends.

**File Utility**

Alternatively, to edit the internal memory or the USB flash drive contents (create/ delete/ rename files and folders) or to edit the default file path, press *File Utilities* from the side menu. See the user manual for details

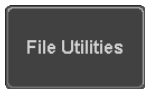

**Coupling and tracking waveforms settings**

**Background**

GEN1 and GEN2 waveforms can be coupled in terms of frequency and/or amplitude. Similarly, waveform settings can also be tracked and be duplicated from one waveform to the other.

**Panel Operation**

1. From the bottom menu of the AWG menu:

Press *UTIL* to enter the Utility menu.



You can press on the *Preset* button from the side menu to reset both wave generators to a 0V DC waveform.



2. Press *Dual Chan* from the side menu to enter the coupling and tracking menus.

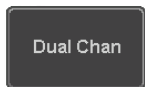

Tracking settings 3. From the side menu press *Tracking* to set the tracking mode to ON or OFF.



Tracking: ON, OFF

When Tracking is ON, all parameters set to one waveform will be copied to the other one and vice-versa.



Note

Tracking mode cannot be used together with the Frequency or Amplitude Coupling. Setting the Tracking mode to ON will disable any Coupling settings.

Frequency coupling

4. From the side menu press *Freq Cpl*

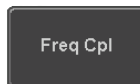

5. Press *Freq Cpl Type* to set the type of frequency coupling.



Freq Cpl Type: OFF, Offset, Ratio

Frequency from both generated waveforms can be coupled with a fixed offset or with a constant ratio.

6. Select *Offset* from the *Freq Cpl Type* menu and press *Offset* on the side menu to configure the offset of the frequency coupling.

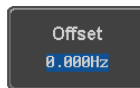

- Use the Left and Right arrow keys to select a base unit and use the variable knob to increase or decrease the offset by that base unit, as shown in the Offset window.

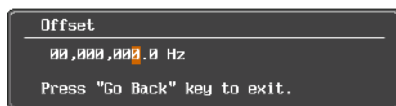

- Default can be pressed to set the Offset to 0.0Hz.
- Press Go Back to leave the menu.

- Select *Ratio* from the *Freq Cpl Type* menu and press *Ratio* on the side menu to configure the ratio of the frequency coupling.



- Use the Left and Right arrow keys to select a base unit and use the variable knob to increase or decrease the ratio by that base unit, as shown in the Ratio window.

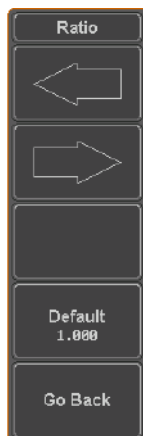
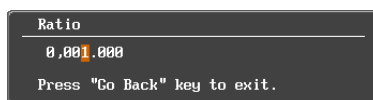

- Default can be pressed to set the Ratio to 1.000.
- Press *Go Back* to leave the menu.

- Press again *Go Back* to leave the menu Frequency Coupling menu.

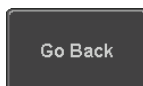





Note

Frequency Coupling cannot be set if Tracking is ON. Configuring Frequency Coupling parameters will disable the Tracking mode.

Amplitude coupling

15. Press *Ampl Cpl* to set the amplitude coupling to ON or OFF.



Ampl Cpl:      OFF, ON

When set to ON, amplitude from both generated waveforms will be duplicated from one to the other one.



Note

Amplitude Coupling cannot be set if Tracking is ON. Configuring Amplitude Coupling will disable the Tracking mode.

Reset the phase

16. You can also reset the phase to 0° between the two waveforms by pressing *S\_Phase*.

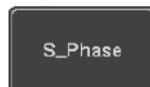

# A APPLICATIONS

---

Introduction.....	259
Overview.....	259
Running Applications.....	260
Go-NoGo application.....	261
DVM application.....	266
Data Log application.....	268
Digital Filter application.....	270
Mask application.....	272
Select the source channel.....	272
Configure the mask violation.....	273
Auto Mask.....	274
User Defined Mask / Create Mask.....	277
User-defined Mask File Format.....	280

# Introduction

## Overview

---

**Background**      The Application (APP) function allows different software applications to be run. The MSO-2000E/2000EA comes pre-installed with a number of apps, as described below. Please see your local GW Instek distributor for the latest information on new apps.

---

**Included Applications**      **Go/No-Go**      The Go/No-Go application can be used to set threshold boundaries for input signals. Go/No-Go tests to see if a waveform will fit inside a user-specified maximum and minimum amplitude boundary (template).

---

**DVM**      The DVM application displays a digital voltage meter readout that floats on the top left-hand side of the screen.

---

**Data Log**      The Data Log app will log waveform data and/or screenshots at set intervals for set duration of time.

---

**Digital Filter**      Adds a digital low or high filter to any of the input channels. Each filter can have a user-defined cutoff frequency set.

---

**Mask**      Create shape templates for signal comparison.

---

Mount Remote Disk	This app allows the scope to mount a network share drive.
Demo	The Demo app, when combined with the GDB-03 demo board, allows the scope to trigger a number of different signals from the demo board.

## Running Applications

**Background** The MSO-2000E/2000EA comes pre-installed with a number of apps which can be activated from a dedicated menu.

**Panel Operation** 1. Press the *APP* key.



2. Press *APP* from the bottom menu.



3. Scroll through each application using the *Variable* knob.



4. Select an application by pressing the *Select* key twice.

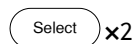

## Go-NoGo application

**Background** The Go-NoGo test checks if a waveform fits inside a user-specified maximum and minimum boundary. Boundary templates are automatically created from a source channel. Boundary tolerances and violation conditions can be set.

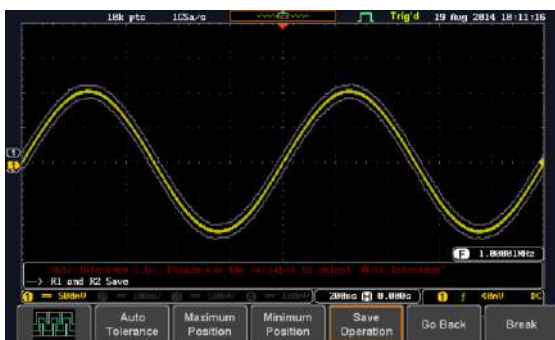

Choose the Go\_NoGo application from the APP menu. See page 260.

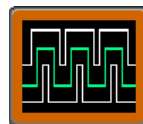





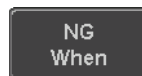

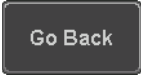

**Set Go-NoGo Conditions** Select the Go-NoGo conditions (NG When) and actions when a Go-NoGo condition has been met (Violating).

1. Press *NG When* from the bottom menu and select the NoGo conditions:

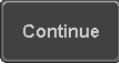
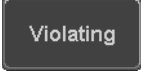
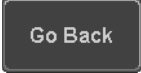

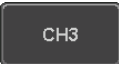
**Enter** Enter: Sets the NoGo condition to when the input signal stays within the limit boundary.

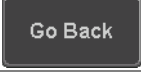
**Exit** Exit: Sets the NoGo condition to when the input signal exceeds the limit boundary.

	<p>2. Press <i>Go Back</i> to return to the previous menu.</p>	
<p>Set Go-NoGo Actions</p>	<p>3. Press <i>Violating</i> to set what action to perform when a signal violates the Go-NoGo conditions.</p> <p> The waveform stops when the conditions are violated.</p> <p> Ignore violations and continue to monitor the signal. Each violation is counted.</p>	
	<p>4. Press <i>Go Back</i> to return to the previous menu.</p>	
<p>Set Go-NoGo Source</p>	<p>5. Press <i>Compare Source</i> from the bottom menu to set the Go-NoGo boundary source.</p> <p> Sets CH1 as the source.</p> <p> Sets CH2 as the source.</p> <p> Sets CH3 as the source.</p> <p> Sets CH4 as the source.</p>	
<p>Set Boundary Tolerance</p>	<p>6. Press <i>Go Back</i> to return to the previous menu.</p>	
	<p>7. To set the Go-NoGo boundary tolerance, press <i>Reference Mode</i>.</p>	

Auto Tolerance      8. To set the boundary tolerance as a percentage offset from the source waveform, press *Auto Tolerance* and use the Variable knob.



Offset      0.4% ~ 40% (.4% steps)

Maximum and Minimum Position      9. To manually set the template tolerance, press *Minimum Position* or *Maximum Position* and use the Variable knob to set the absolute minimum or maximum position.



or



Range      Voltage division range

Save Boundary Template      10. Press *Save Operation* to save the tolerance boundaries.

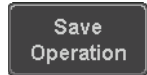

11. The Maximum Position tolerance will be saved to reference waveform R1, and the Minimum Position tolerance to R2.

12. Press *Go Back* to return to the previous menu.

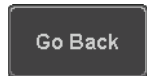

Start Go-NoGo      Press *Enable* to start the Go-NoGo test. The Enable button will change to Disable. Pressing *Disable* will stop the Go-NoGo test and toggle the button back to Enable.

If the Violating setting was set to Stop, press *Enable* to restart the test after it has stopped.

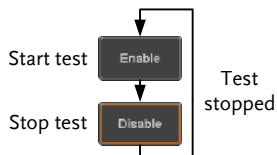

**Results**

When Go-NoGo is running, the violation/test ratio is displayed in the bottom left-hand corner. The first digit represents the number of violations, and the right hand digit represents the number of tests.

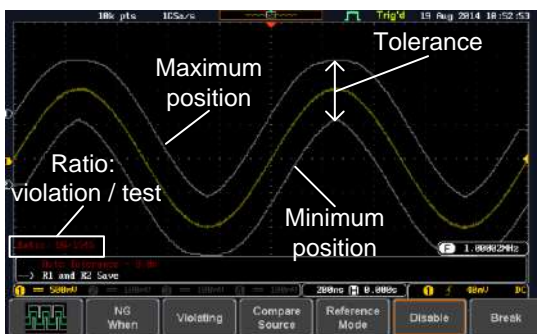

Exit the Application

To exit the application, press *Break*.

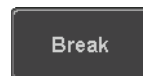

 **Note**

After you exit the Go/NoGo app, the boundary templates that were saved to R1 & R2 reference waveforms will still be turned on. See page 306 to turn the reference waveforms off.



Using the Go-NoGo Output

To output the Go-NoGo results to an external device, the Go-NoGo rear panel terminal (open collector) can be used. The Go-NoGo terminal will output a positive pulse each time a NoGo violation has occurred for a minimum of 500us. The voltage of the pulse depends on the external pull-up voltage.



Timing Diagram

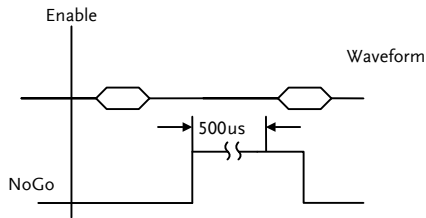

Circuit Diagram

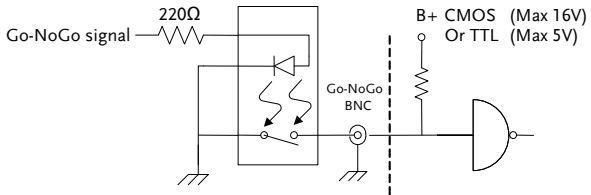

## DVM application

**Background** The DVM app is a digital voltage meter or digital current meter readout that floats on the top left-hand side of the screen. However, please note that if the cursors (refer to page 65) are turned on, the DVM readout will be replaced by the cursor readout.

The DVM app allows you to measure the AC RMS, DC, DC RMS, Duty and frequency of an input signal. This software is especially useful for those measurement applications that require both a DSO and a basic DVM to be used at the same time.





**Basic Features:**

- 300V input (peak AC + DC) CAT 1
- 3 digit resolution for voltage measurements
- 5 digit resolution for frequency
- Input channel selection

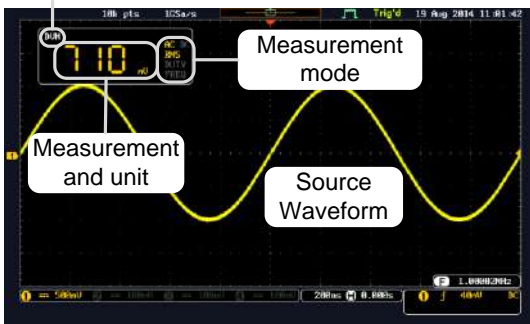
**Example**

DVM function indicator

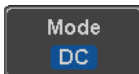

- Panel Operation Choose the DVM application from the APP menu. See page 260. 
- Set Source
1. Press *Source* and select the source channel for the DVM. The probe type setting (voltage or current) determines whether the function acts as a digital voltmeter or as a digital current meter for the selected source. See page 121 to set the probe type.  
Source CH1 ~ CH4 
- Mode
- The Mode setting determines the measurement mode for the meter.
2. Press *Mode* and select the mode.  
Mode AC RMS, DC, DC RMS, Duty, Frequency 
- Turn On/Off
3. Press *DVM* and toggle DVM on.  
The DVM app will remain running in the background even if other functions are turned on. 

## Data Log application

**Background** The Data Log app will log the current waveform data or screenshot at set intervals for a set duration of time.

Basic Features:

- Log up to 100 hours of images or waveform data.
- Interval times of up to 2 seconds (waveform) or 5 seconds (images).

**Example**

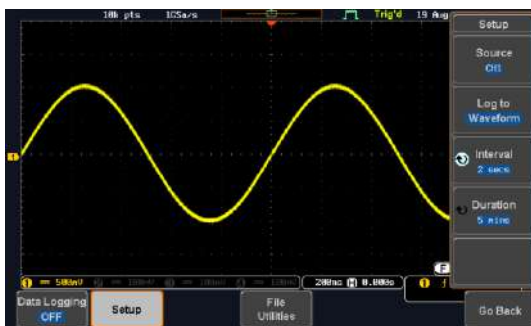

**Panel Operation** Choose the Data Log application from the APP menu. See page 260.



1. Press *Setup*.



2. Press *Log to* from the side menu and select what type of data to log, waveform data or screenshots.

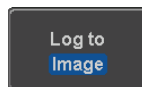

Log to Image, Waveform

3. Press *Source* from the side menu and select a source channel to log if waveforms are to be logged.



Source CH1 ~ CH4, D0~D15, All Displayed

4. Press *Interval* and set the logging interval time.



Interval Data: 2secs ~ 2mins  
Image: 5secs ~ 2mins

5. Press *Duration* and select the logging duration time.

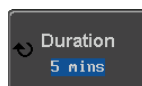

Duration 5mins ~ 100hrs.

6. From the bottom menu, press *File Utilities* and set the save file path. See the File Utilities chapter (page 308) for details.

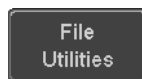

Turn On/Off

7. Press *Data Logging* from the bottom menu and toggle Data Logging on.



The data/images will be saved to the designated file path when Data Logging is turned on.

The Data Logging app will remain running in the background even if other functions are turned on.

Set File Path

8. Press *File Utilities* to set the file path.

Page 308

## Digital Filter application

**Background** The Digital Filter app is a digital high or low pass filter with a selectable cutoff frequency. The digital filter can be applied to analog channel individually or together using the tracking functionality. The Digital Filter is not applicable to the Digital channels.

**Basic Features:**

- High pass or low pass filtering of analog channels.
- Selectable cutoff frequencies.
- Tracking function

**Example**

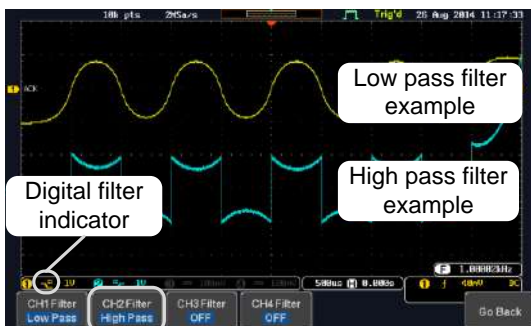

Digital filter type or status

CH1 input: 2Vpp 1kHz square wave, low pass filter with 1kHz cutoff frequency.

CH2 input: 2Vpp 1kHz square wave, high pass filter with 1kHz cutoff frequency.

Panel Operation Choose the Digital filter application from the APP menu. See page 260.

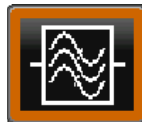

Set Source

1. Select a source channel by pressing *CH1 Filter*, *CH2 Filter*, *CH3 Filter* or *CH4 Filter*.



2. From the side menu press *Filtering* and turn on.

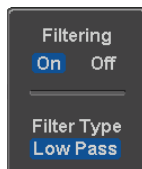

3. Press *Filter Type* and select low or high pass filter.

Type            Low Pass, High Pass

4. If Low Pass was selected, press *Upper Limit* to set the low pass cutoff frequency. Likewise if High Pass was selected, press *Lower Limit* to set the high pass cutoff frequency. Only one option will be available at a time.

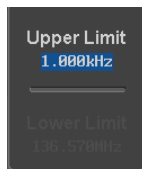

Upper Limit    1Hz ~ 500MHz

Lower Limit    1Hz ~ 500MHz

Tracking

5. Press *Tracking* if you want the settings of the digital filter on each channel to be the same. When a setting is changed on one channel, it is reflected on the other channels.

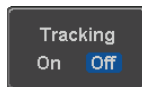

The digital filter settings will still apply to the relevant input signals after leaving the app, unless turned off.

## Mask application

**Background** The Mask application allows the user to create shape templates for easy comparison of an input signal with a defined shape.

**Panel Operation** Choose the Mask application from the APP menu. See page 260.



## Select the source channel

**Step** 1. Press the *Compare Source* button from the bottom menu.



2. Press the CH1 button from the side menu and use the *Variable* knob to select a source channel (CH1, CH2 for 2 channels models and CH1~CH4 for 4 channels models) as a compare source.



VARIABLE





## Configure the mask violation

---

Step

1. Press the *Violation* button from the bottom menu.

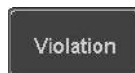

2. Press the *Stop* button to stop the data acquisition and freeze the screen when the source waveform crosses the mask boundary (mask violation condition). Conversely, press the *Continue* button to continue acquiring data even when a mask violation condition is encountered.



3. Toggle the *Save* button to *On* will save a file each time a mask violation condition is encountered (see above). The save mode (file type) depends on the hardcopy save setting (see page 315).



## Auto Mask

Step

1. Press the *Auto Mask* button from the bottom menu to create a mask shaped out from an existing waveform. 
2. Press the *Reference Source* button from the side menu to select the pattern the mask will be shaped on.
3. Use the *Variable* knob to select the reference source (CH1 or CH2 for 2 channels model and CH1~CH4 for 4 channels models).

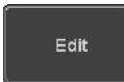

4. Press the *Edit* button from the side menu if you want to further adjust the mask pattern. Otherwise, go to step 9 below to create the mask directly without adjustment. 
5. Press the *Unit* button from the side menu and use the *Variable* knob to select either *Divisions* (graticule division fractions) or *Current* (X or Y axis actual scale units) as the units to set the mask deviation from its original pattern.

6. Press the *X Mask* button from the side menu and use the *Variable* knob to adjust the horizontal deviation of the mask compared to its original pattern

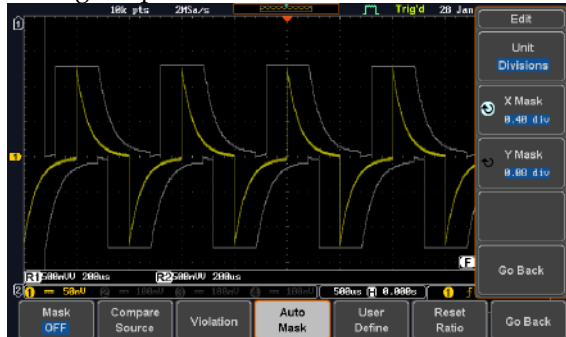

7. Press the *Y Mask* button from the side menu and use the *Variable* knob to adjust the vertical deviation of the mask compared to its original pattern.

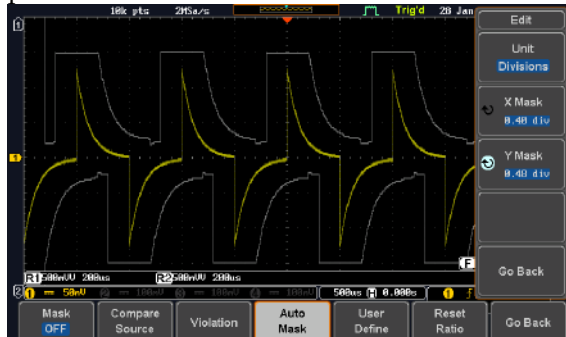

8. Press the *Go Back* button from the side menu.

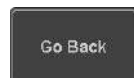

9. Press the *Create Mask* button from the side menu.

A mask is created (as shown in the below diagram) and can now be used.

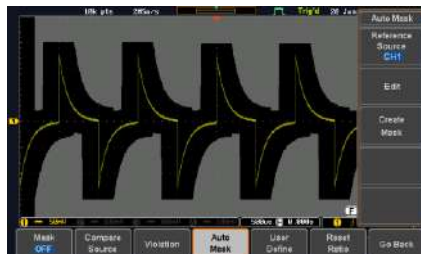

10. Press the *Auto Mask* button from the bottom menu to close auto mask function.



11. Press the *Mask ON* button from the bottom menu to execute the mask function and start comparing the source channel (set in the compare source menu) with the mask.

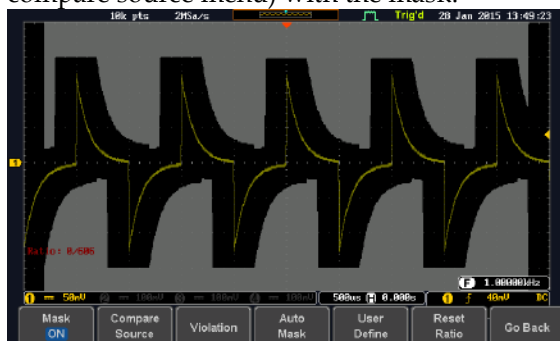

## User Defined Mask / Create Mask

**Background** A user-defined mask can be created. Up to 8 areas of any form, each made of up to 10 points, can be built out and juxtaposed to each other to form the user-defined mask pattern.

**Step**

1. Press the *User Define* button from the bottom menu.

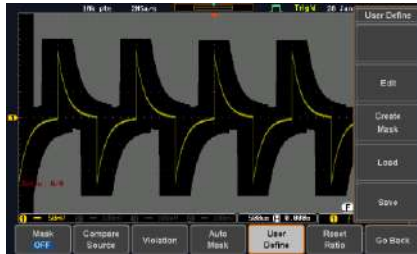

2. Press the *Edit* button from the side menu.



**Create an area**

3. Press the *Area Number* button from the side menu and use the *Variable* knob to select 1 out of 8 areas that can be created to build the mask pattern and start to shape it.



4. Press the *Unit* button from the side menu and use the *Variable* knob to either select *Divisions* (graticule division fractions) or *Current* (Actual oscilloscope X- and Y-axis scale units) as the points position units.
5. Press the *Edit Points* button from the side menu to start shaping the pattern of the area you selected.

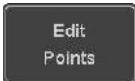

- Edit the first point
6. Press the *Points Number* button from the side menu and use the *Variable* knob to select the first point that will shape the area pattern. Up to 10 points can form an area pattern.
  7. Press the *Points Number ON* button from the side menu to activate the point.
  8. Press the *Y Mask* button from the side menu and use the *Variable* knob to adjust the vertical position of the point (Y-axis).
  9. Press the *X Mask* button from the side menu and use the *Variable* knob to adjust the horizontal position of the point (X-axis).



Edit the other points 10. Repeat the above steps 6 to 9 to add other points to the area and until you finalize the shape of this first area. Then press the *Go Back* button to exit the Edit Points menu.

Create other areas 11. Repeat the above steps for as many areas as you need to create your mask pattern.

12. Press the *Go Back* button again from the side menu.

13. Press the *Create Mask* button from the side menu.

A user-defined mask is created (as shown in the below diagram) and can now be used.

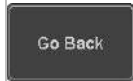

Note: Mask area must be defined clockwise sequentially. (Examples: two diagrams on the right)

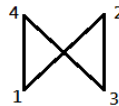
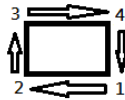

Save the user-defined mask

14. Press the *Save* button from the side menu.

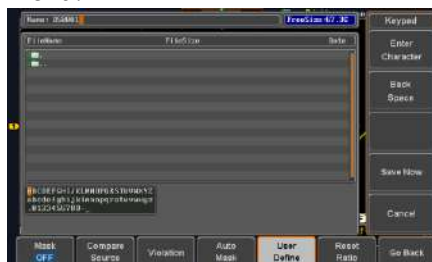

15. Use the variable knob and the select key to change the name of the file if needed and press the *Save Now* button from the side menu to save the user-defined mask.

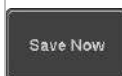

Load a user-defined mask

16. From the User Define menu, you can also load an existing mask. Press the *Load* button from the side menu, use the *Variable* knob to select the file, and press the *Select* key twice to load the mask.

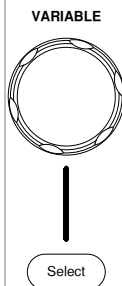

## User-defined Mask File Format

---



**Background**            The user-defined mask files can be created out of support (from an external computer for example) and uploaded to the MSO-2000E/2000EA Mask application with a USB key device.

                                 Create an unformatted text file respecting the format described below.

---

**File extension**        *File\_name.MSK*

---

**Format**                Format,2.0E,  
                                  Total Area Number,1,  
                                  Area Number,1,  
                                  Points Number,3,  
                                  0.00,2.00,  
                                  1.00,1.00,  
                                  -1.00,1.00,

---

**Example**  
 (with Division  
 units)                    Format,2.0E,  
                                  Total Area Number,2,  
                                  Area Number,1,  
                                  Points Number,4,  
                                  0.00,2.00,  
                                  1.00,1.00,  
                                  0.00,0.00,  
                                  -1.00,1.00,  
                                  Area Number,2,  
                                  Points Number,3,  
                                  0.00,-2.00,  
                                  1.00,-1.00,  
                                  -1.00,-1.00,

# SAVE/RECALL

---

File Format/Utility .....	283
Image File Format .....	283
Waveform File Format .....	283
Spreadsheet File Format .....	284
Setup File Format .....	286
<b>Create/Edit Labels .....</b>	<b>289</b>
<b>Save .....</b>	<b>292</b>
File Type/Source/Destination .....	292
Save Image .....	293
Save Waveform .....	295
Save Setup .....	297
<b>Recall .....</b>	<b>300</b>
File Type/Source/Destination .....	300
Recall Default Panel Setting .....	301
Recall Waveform .....	303
Recall Setup .....	304
<b>Reference Waveforms .....</b>	<b>306</b>
Recall and Display Reference Waveforms .....	306

## File Format/Utility

### Image File Format

---

Format	*.bmp or *.png
Default Filename	DSxxxx.bmp/png
Contents	The display image is 800 by 480 pixels. The background color can be inverted (Ink saver function). Each image file is saved to the current file path as a bitmap or PNG file.

### Waveform File Format

---

Format	DSxxxx.lsf, CH1~CH4.lsf	
	The LSF file format efficiently stores waveforms. This is the file format used for storing and recalling all waveforms that are used with the MSO-2000E/2000EA series except digital channel waveforms.	
Filename	DSxxxx.lsf	
Waveform Type	CH1 ~ 4	Input channel signal
	REF	Reference waveform
	Math	Math operation result (page 73)
Storage Location	Wave1 ~ Wave20	Waveform files stored to the internal memory. Stored waveforms can be transferred to Ref. 1 ~ 4 to be viewed on the display. (W1 ~ W20 waveforms cannot be directly recalled on the display).

Ref 1~4 Reference waveforms stored in the internal memory, separate from W1 ~ W20. Reference waveforms (Ref 1 ~ 4) can be displayed directly onto the display with amplitude and frequency information. Ref 1~4 are useful for reference purposes. Other waveforms (LSF and W1~20) must be recalled to R1~4 before being displayed.

Contents: The waveform data can be used for detailed analysis. It consists of the horizontal and vertical data used by the waveform.

### Spreadsheet File Format

Format \*.csv (Comma-separated values format, can be opened in spreadsheet applications such as Microsoft Excel).

CSV-formatted files can be stored in either a short-memory format or a long-memory format: Detail CSV, Fast CSV. The number of points that are saved depends on the record length settings.

Detail CSV will record both the horizontal and vertical sample points of the waveform. All the points are recorded in scientific notation for analog data.

Fast CSV will only record the vertical amplitude of the sample points. Fast CSV also contains data that enables the horizontal data points to be reconstructed, such as trigger position, etc. Data is recorded as integers.

Note, however, that only fast CSV can be recalled to the internal memory. Detailed CSV cannot be recalled.

Filename DSxxxx.csv

Waveform Type	CH1 ~ 4	Analog channel signal
	D0 ~ D15	Digital channel signal
	Ref1~4	Reference waveform
	Math	Math operation result (page 73)
	All Displayed	All the waveforms on the display.

Contents:  
Detail CSV

Detail CSV waveform data contains channel information such as vertical and horizontal position of a signal for all the recorded points. The following information is included in Detail CSV, where applicable:

- Format (scope type)
- Trigger Level
- Label
- Vertical units
- Vertical position
- Horizontal scale
- Horizontal mode
- Firmware
- Mode
- Horizontal data
- Memory length
- Source
- Probe ratio
- Vertical scale
- Horizontal units
- Horizontal position
- Sampling period
- Time
- Vertical data

Contents:  
Fast CSV

The following information is included in the Fast CSV waveform files, where applicable:

- Format (scope type)
- IntpDistance (input trigger distance)
- Trigger level
- Vertical units
- Memory length
- Trigger address
- Source
- Vertical units div

- Vertical units extend div
- Probe type
- Vertical scale
- Horizontal units
- Horizontal position
- SincET mode (sampling mode)
- Horizontal old scale
- Firmware
- Mode
- Label
- Probe ratio
- Vertical position
- Horizontal scale
- Horizontal mode
- Sampling period
- Horizontal old position
- Time
- Raw vertical waveform data

## Setup File Format

Format	DSxxxx.set (proprietary format) The setup file saves or recalls the following settings.		
Contents	Acquire	<ul style="list-style-type: none"> <li>• Mode</li> <li>• Sample rate</li> <li>• XY</li> </ul>	<ul style="list-style-type: none"> <li>• Sample mode</li> <li>• Record Length</li> </ul>
	Display	<ul style="list-style-type: none"> <li>• Mode</li> <li>• Persistence</li> <li>• Waveform intensity</li> <li>• Graticule intensity</li> </ul>	<ul style="list-style-type: none"> <li>• Backlight intensity</li> <li>• Graticule</li> <li>• Backlight</li> <li>• Auto-dim</li> </ul>

- |         |  |  |
|---------|--|--|
| Channel | <ul style="list-style-type: none"> <li>• Scale</li> <li>• Channel</li> <li>• Coupling</li> <li>• Impedance</li> <li>• Invert</li> <li>• Bandwidth</li> </ul> | <ul style="list-style-type: none"> <li>• Expand</li> <li>• Position</li> <li>• Probe</li> <li>• Probe attenuation</li> <li>• Deskew</li> </ul> |
|---------|--|--|

- |        |   |   |
|--------|---|---|
| Cursor | <ul style="list-style-type: none"> <li>• Horizontal cursor</li> <li>• H Unit</li> </ul> | <ul style="list-style-type: none"> <li>• Vertical cursor</li> <li>• V Unit</li> </ul> |
|--------|---|---|

- |         |  |   |
|---------|--|---|
| Measure | <ul style="list-style-type: none"> <li>• Source</li> <li>• Gating</li> <li>• Statistics</li> </ul> | <ul style="list-style-type: none"> <li>• Display</li> <li>• High-Low</li> <li>• Reference levels</li> </ul> |
|---------|--|---|

- |            |   |
|------------|---|
| Horizontal | <ul style="list-style-type: none"> <li>• Scale</li> </ul> |
|------------|---|

- |      |  |  |
|------|--|--|
| Math | <ul style="list-style-type: none"> <li>• Source1</li> <li>• Operator</li> <li>• Source2</li> </ul> | <ul style="list-style-type: none"> <li>• Position</li> <li>• Unit/Div</li> <li>• Math Off</li> </ul> |
|------|--|--|

- |          |  |  |
|----------|--|--|
| FFT Math | <ul style="list-style-type: none"> <li>• Source</li> <li>• Vertical Units</li> <li>• Window</li> </ul> | <ul style="list-style-type: none"> <li>• Vertical position</li> <li>• Horizontal position</li> </ul> |
|----------|--|--|

- |               |  |  |
|---------------|--|--|
| Advanced Math | <ul style="list-style-type: none"> <li>• Expression</li> <li>• VAR1</li> <li>• VAR2</li> </ul> | <ul style="list-style-type: none"> <li>• Position</li> <li>• Unit/Div</li> </ul> |
|---------------|--|--|

- |         |   |  |
|---------|---|--|
| Trigger | <ul style="list-style-type: none"> <li>• Type</li> <li>• Source</li> <li>• Coupling</li> <li>• Alternate</li> <li>• Rejection</li> <li>• Noise Rejection</li> </ul> | <ul style="list-style-type: none"> <li>• Slope</li> <li>• Level</li> <li>• Mode</li> <li>• Trigger When</li> <li>• Timer</li> <li>• Holdoff</li> </ul> |
|---------|---|--|

Utility	<ul style="list-style-type: none"><li>• Language</li><li>• Hardcopy key</li><li>• File Format</li></ul>	<ul style="list-style-type: none"><li>• Ink Saver</li><li>• Assign Save</li><li>• Probe Comp.</li></ul>
Save/ recall	<ul style="list-style-type: none"><li>• Image file format</li></ul>	<ul style="list-style-type: none"><li>• Data file format</li></ul>



## Create/Edit Labels

**Overview** Reference files, Setup files and the analog and digital input channels can have individual file labels set.

For the analog channels and reference waveforms, the file label can be displayed next to the channel/reference indicator.

The file labels are also used to easily identify reference files, setup files or channels when saving or recalling waveforms and setups.

### Example

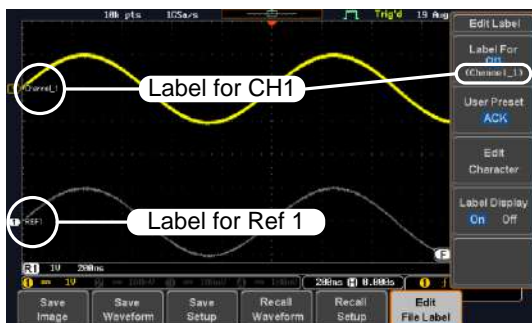

In the example above, the file label for channel 1 is displayed next to the channel indicator and is also displayed in the *Edit Label* menu. The Ref\_1 file label is shown next to the reference indicator.

**Panel Operation** 1. Press the *Save/Recall* key from the front panel.



2. Press *Edit File Label* from the bottom menu.

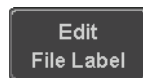

- 3. Press *Label For* and select the item that you want to create the label for.



Label For CH1~CH4, Ref1~4, Set1~20, Math



Labels for digital channels can only be changed from the Logic Analyzer menu. See page 220.

- 4. To choose a preset label, Press *User Preset* from the side menu and choose a label.

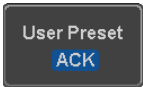

Labels ACK, AD0, ANALOG, BIT, CAS, CLK, CLOCK, CLR, COUNT, DATA, DTACK, ENABLE, HALT, INT, IN, IRQ, LATCH, LOAD, NMI

Edit Label

- 5. Press *Edit Character* to edit the current label.



- 6. The Edit Label window appears.

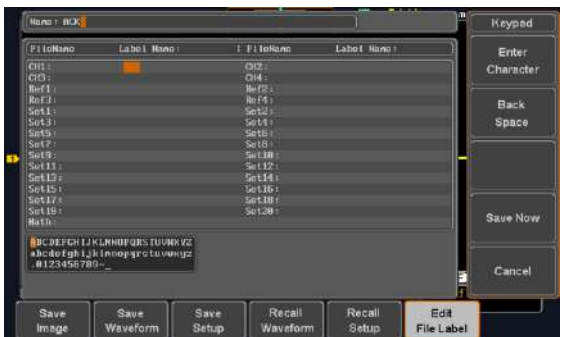

- 7. Use the Variable knob to highlight a character.



Press *Enter Character* to select a number or letter.

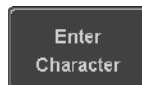

Press *Back Space* to delete a character.



Press *Save Now* to save the label and return to the previous menu.

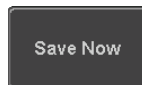

To cancel the editing the label and return to the previous menu, press *Cancel*.

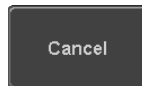

Display Label

To display the currently selected file label on the screen next to its respective indicator, toggle *Label Display* to On.

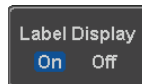

Conversely, if you want to remove the currently selected file label from the display, toggle *Label Display* to Off.

## Save

### File Type/Source/Destination

Item	Source	Destination
Panel Setup (DSxxxx.set)	<ul style="list-style-type: none"> <li>• Front panel settings</li> </ul>	<ul style="list-style-type: none"> <li>• Internal memory: Set1 ~ Set20</li> <li>• File system: Disk, USB</li> </ul>
Waveform Data (DSxxxx.csv) (DSxxxx.lsf) (CH1~CH4.lsf, Ref1~Ref4.lsf, Math.lsf)* ALLxxxx.csv	<ul style="list-style-type: none"> <li>• Channel 1 ~ 4</li> <li>• Digital channel D0~D15***</li> <li>• Math operation result</li> <li>• Reference waveform Ref1~4</li> <li>• All displayed waveforms</li> </ul>	<ul style="list-style-type: none"> <li>• Internal memory: Reference waveform Ref1~4, Wave1 ~ Wave20</li> <li>• File system: Disk, USB</li> </ul>
Display Image (DSxxxx.bmp/png) (Axxx1.bmp/png)**	<ul style="list-style-type: none"> <li>• Display image</li> </ul>	<ul style="list-style-type: none"> <li>• File system: Disk, USB</li> </ul>

\*Stored in ALLXXXX directories when All Displayed waveforms are saved.

\*\*Stored in ALLXXXX directories when the Hardcopy key is assigned to save Waveform, Setup or All.

\*\*\*Can only be saved to .csv files.

Note: By default all filenames/directories are named DSxxxx/ ALLxxxx where xxxx is a number starting from 0001 and is incremented by one after each save.

## Save Image

Images can be saved either using the Save/Recall key or by using the Hardcopy key. To save images using the Hardcopy key, see the hardcopy section on page 315.

- Panel Operation
1. To save to USB, connect a USB drive to the front panel USB port. If a USB drive is not connected, images can still be saved to the internal memory.

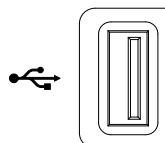

2. Press the *Save/Recall* key from the front panel.



3. Press *Save Image* from the bottom menu.



4. Press *File Format* to choose PNG or BMP file types.

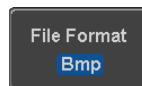

Range DSxxxx.bmp, DSxxxx.png

5. Press *Ink Saver* to toggle Ink Saver On or Off.

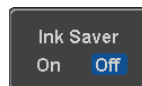

Ink Saver On

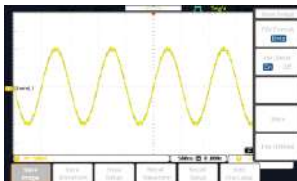

Ink Saver Off



6. Press *Save* from the side menu to save the display as an image file.



7. You will automatically be taken to a file utility where you will be able to edit the name of the file.

8. To edit the file name, use the *Variable* knob to highlight a character.



Press *Enter Character* or the *Select* key to select a number or letter.

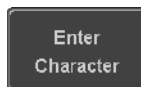

Press *Back Space* to delete a character.



9. Press *Save Now* to save the file. The file name need not have been edited to save the file.



Note: Pressing *Cancel* will cancel the save operation and return you to the *Save/Recall* menu.

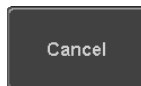

After *Save Now* has been pressed the file will be saved.



**Note** The file will not be saved if the power is turned off or the USB drive is taken out before the message ends.

**File Utility** To edit the internal memory or the USB flash drive contents (create/delete/rename files and folders) or to edit the default file path, press *File Utilities* from the side menu.

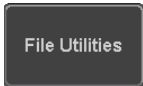

## Save Waveform

---

**Panel Operation** 1. To save to an external USB flash drive, connect the drive to the front panel USB port. If a USB drive is not connected, files can still be saved to the internal memory.

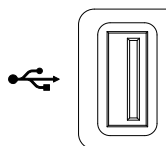

2. Press the *Save/Recall* key from the front panel.



3. Press *Save Waveform* from the bottom menu.



4. Choose the *From* waveform on the side menu.

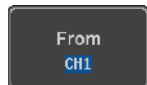

Source CH1~4, Math, Ref1~4, All Displayed

5. Press *To* (internal memory) or *To File* and choose a destination to save.



To Ref1~4, Wave1~20

To File Format: LSF, Detail CSV, Fast CSV

6. Press *Save* to save the file.



7. If you are saving to a file, a file utility appears where you will be able to edit the name of the file from the default “DSXXX” filename.

8. To edit the filename, use the *Variable* knob to highlight a character.



Press *Enter Character* or the *Select* key to select a number or letter.

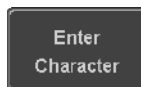

Press *Back Space* to delete a character.



9. Press *Save Now* to save the file. The filename need not have been edited to save the file.



Note: Pressing *Cancel* will cancel the save operation and return you to the *Save/Recall* menu.

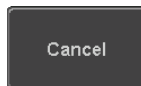

After *Save Now* has been pressed the file will be saved.



**Note** The file will not be saved if the power is turned off or the USB drive is taken out before the message ends.



**File Utility** To edit the internal memory or the USB flash drive contents (create/delete/rename files and folders), press *File Utilities*.

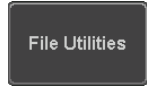

## Save Setup

---

**Panel Operation** 1. To saving to an external USB flash drive connect the drive to the front or rear panel USB port. If a USB drive is not connected, files can be saved to the internal memory.

Front Panel

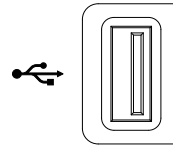

2. Press the *Save/Recall* key from the front panel.



3. Press *Save Setup* from the bottom menu.



4. Press *To* (internal memory) or *To File* and choose a destination to save to.



To Set1~Set20

To File DSxxxx.set

5. Press *Save* to confirm saving. When completed, a message appears at the bottom of the display.

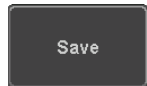

6. If you are saving to a file, a file utility appears where you will be able to edit the name of the file from the default "DSxxxx" filename.

- To edit the filename, use the *Variable* knob to highlight a character.



Press *Enter Character* or the *Select* key to select a number or letter.

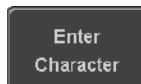

Press *Back Space* to delete a character.



- Press *Save Now* to save the file. The filename need not have been edited to save the file.

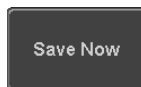

Note: Pressing *Cancel* will cancel the save operation and return you to the *Save/Recall* menu.

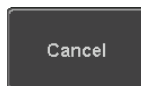

After *Save Now* has been pressed the file will be saved.



Note

The file will not be saved if the power is turned off or the USB drive is taken out before the message ends.

File Utility

To edit the internal memory or the USB flash drive contents (create/ delete/ rename files and folders) or to set the file path, press *File Utilities*.

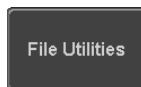

Edit Label

To edit labels for Setup files, press *Edit Label*. For more details on editing labels, see page 289.

A dark gray rectangular button with rounded corners and a thin white border. The text "Edit Label" is centered on the button in a light gray, sans-serif font.

Edit Label

## Recall

### File Type/Source/Destination

Item	Source	Destination
Default Panel Setup	<ul style="list-style-type: none"> <li>• Factory installed setting</li> </ul>	<ul style="list-style-type: none"> <li>• Current front panel</li> </ul>
Reference Waveform	<ul style="list-style-type: none"> <li>• Internal memory: Ref1~4</li> </ul>	<ul style="list-style-type: none"> <li>• Current front panel</li> </ul>
Panel Setup (DSxxxx.set)	<ul style="list-style-type: none"> <li>• Internal memory: S1 ~ S20</li> <li>• File system: Disk, USB</li> </ul>	<ul style="list-style-type: none"> <li>• Current front panel</li> </ul>
Waveform Data (DSxxxx.lsf, DSxxxx.csv**, (CH1~CH4.lsf, Ref1~Ref4.lsf, Math.lsf)*	<ul style="list-style-type: none"> <li>• Internal memory: Wave 1 ~ Wave20</li> <li>• File system: Disk, USB</li> </ul>	<ul style="list-style-type: none"> <li>• Reference waveform 1 ~ 4</li> </ul>

\*Recalled from ALLXXX directories. Note that Allxxxx.csv cannot be recalled to the oscilloscope.

\*\*Detail CSV files cannot be recalled to the oscilloscope.

## Recall Default Panel Setting

---

Panel Operation 1. Press the *Default* key.

Default

2. The screen will update with the default panel settings.

---

Setting Contents The following is the default (factory) setting contents.

---

Acquire	Mode: Sample	XY: OFF
	Record Length: 10k	Expand: By Center
Display	Mode: Vector	Persistence: 240ms
	Waveform intensity: 50%	Graticule intensity: 50%
	Backlight Intensity: 80%	Backlight Auto-dim: On
	Time: 10min	Graticule: full 
Channel	Scale: 100mV/Div	CH1: On
	Coupling: DC	Impedance: 1MΩ
	Invert: Off	Bandwidth: full
	Expand: By Ground	Position: 0.00V
	Probe: Voltage	Probe attenuation: 1x
	Deskew: 0s	
Cursor	Horizontal cursor: Off	Vertical Cursor: Off
Measure	Source: CH1	Gating: Screen
	Display All: Off	High-Low: Auto
	Statistics: Off	Mean & Std Dev
		Samples: 2
	High Ref: 90.0%	Mid Ref: 50.0%
	Low Ref: 10.0%	

Horizontal	Scale: 10us/Div	Position: 0.000s
Math	Source1: CH1	Operator: +
	Source2: CH2	Position: 0.00 Div
	Unit/Div: 200mV	Math Off
FFT	Source: CH1	Vertical Units: dBV RMS
	Window: Hanning	Vertical: 20dB
	Horizontal:5MHz/div	
Advanced Math	Expression: CH1+CH2	VAR1: 0
	VAR2: 1	Position: 0.00Div
	Unit/div: 500mV	
APP	App: Go-NoGo, DVM, Datalog, Mount Remote Disk	
Trigger	Type: Edge	Source: CH1
	Coupling: DC	Alternate: Off
	Noise Rejection: Off	Slope: Positive
	Level: 0.00V	Mode: Auto
	Holdoff: 10.0ns	
Utility	Hardcopy: Save	Ink Saver: Off
	Assign Save To: Image	File Format: Bmp
	Probe Comp.: 1kHz	

## Recall Waveform

- Panel Operation
1. For recalling from an external USB flash drive, connect the drive to the front or rear panel USB port.

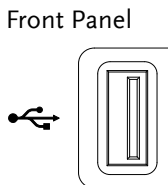

2. The waveform must be stored in advance. See page 295 for waveform store details.

3. Press the *Save/Recall* key.



4. Press *Recall Waveform* from the bottom menu. The Recall menu appears.

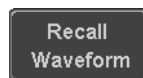

5. Press *From* (internal memory) or *From File* and choose a source to recall from.

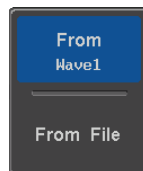

From Wave1~20

From File\* File format: Lsf, Fast Csv

\*Only files in the current file path will be available, this includes files saved in the ALLxxxx directories.

Allxxxx.csv files cannot be recalled to the oscilloscope.

Only the "Fast CSV", "LSF" files can be recalled to the oscilloscope.

6. Press *To* and select the reference waveform to recall to.

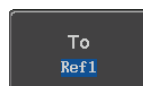

To Ref1~4

7. Press *Recall Now* to recall the waveform. The reference waveform will appear on the screen when successful.

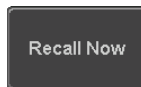

File Utility

To edit USB flash drive contents (create/ delete/ rename files and folders) or to set the file path, press *File Utilities*.

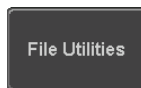

## Recall Setup

Panel Operation

1. (For recalling from an external USB flash drive) Connect the drive to the front or rear panel USB port.

Front Panel

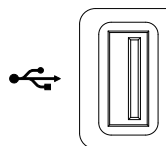

2. Press the *Save/Recall* key.



3. Press *Recall Setup* from the bottom menu.

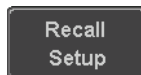



4. Press *From* (internal memory) or *From File* and choose a source to recall from.

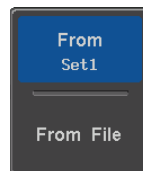

From Set1~20

From File DSxxxx.set (USB, Disk)\*

\* Only files in the current file path will be available.

5. Press *Recall Now* to confirm recalling. When completed, a message appears at the bottom of the display.

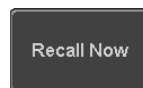

Setup recalled from Set1.



Note

The file will not be recalled if the power is turned off or the USB drive is taken out before the message appears.

File Utility

To edit the internal memory or the USB flash drive contents (create/delete/ rename files and folders) or to set the file path, press *File Utilities*.

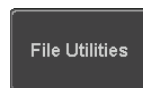

Edit Label

To edit labels for Setup files, press *Edit label*. For more details on editing labels, see page 289.

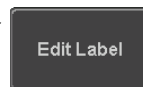

# Reference Waveforms

## Recall and Display Reference Waveforms

**Panel Operation** A reference waveform must be stored in advance. See page 295 to store waveforms as reference waveforms.

1. Press the *REF* key on the front panel.







2. Pressing *R1~R4* repeatedly will toggle the corresponding reference waveform OFF/ON.

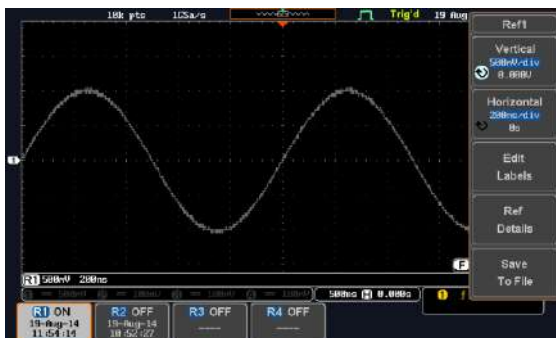
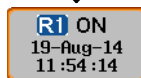

Turning *R1~R4* ON will open the corresponding reference menu.

3. If a reference waveform is ON but not active, its reference menu can be opened by pressing the corresponding *R1~R4* key from the bottom menu.

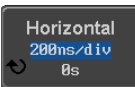
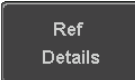

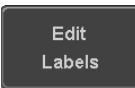
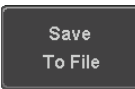
Vertical Navigation	Press <i>Vertical</i> repeatedly from the side menu to choose to edit the vertical position or Unit/Div. Use the Variable knob to edit the values.	
Horizontal Navigation	Press <i>Horizontal</i> repeatedly from the side menu to choose to edit the Time/Div or the horizontal position. Use the Variable knob to edit the value.	
View Reference Waveform Details	Pressing <i>Ref Details</i> will display the reference waveform details.	
Details: Sample Rate, Record Length, Date		
		
Edit Labels	To edit labels for Setup files, press <i>Edit Labels</i> . For more details on editing labels, see page 289.	
Save Reference Waveforms	To save reference waveforms, press <i>Save to File</i> . For more details on saving waveforms, see page 295.	

# FILE UTILITIES

The file utilities are used each time files need to be saved to internal or external memory. The file utilities can create, delete and rename directories or files as well as copy files from internal memory to USB. The File Utilities menu also sets the file path for saving and recalling files from the Save/Recall menu.

---

File Navigation .....	309
Create Folder.....	311
Rename File .....	312
Delete File or Folder .....	313
Copy File to USB .....	314

## File Navigation

The File Utilities menu can be used to choose files or to set the file path for saving/recalling files.

File System

File path

Drive space

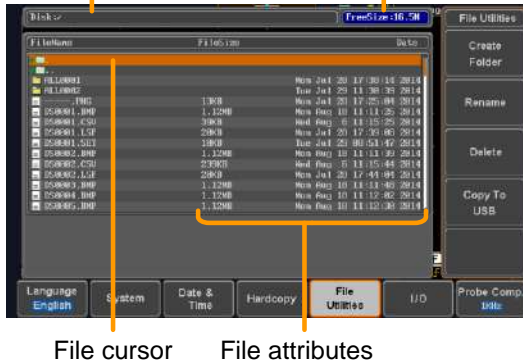

Panel Operation

1. Press the *Utility* key.
2. Press *File Utilities* from the bottom menu.
3. The file system appears.

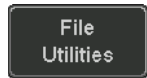

4. Use the *Variable* knob to move the file cursor up and down.

Use the *Select* key to choose a file or directory or to set the file path.

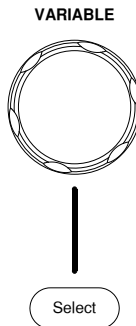

Note

When a USB flash drive is used, the file path is remembered each time the USB flash drive is used. This saves you the hassle of setting the USB file path each time the USB flash drive is inserted into the scope.

# Create Folder

Panel Operation 1. Press the *Utility* key.



2. Press *File Utilities* from the bottom menu.

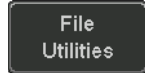

3. Use the *Variable* knob and *Select* key to navigate the file system.

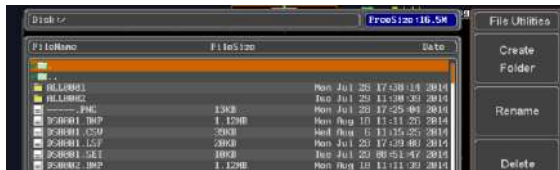

Create Folder 4. Press *Create Folder* to make a new directory at the selected location.

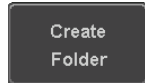

5. Use the *Variable* knob to highlight a character.



Press *Enter Character* or the *Select* key to select a number or letter.

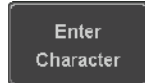

Press *Back Space* to delete a character.



6. Press *Save Now* to create the folder.

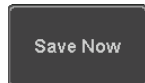

Cancel Press *Cancel* to cancel the operation.



## Rename File

Panel Operation 1. Press the Utility key.



2. Press *File Utilities* from the bottom menu.

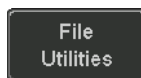

3. Use the Variable knob and select key to choose a file to rename.

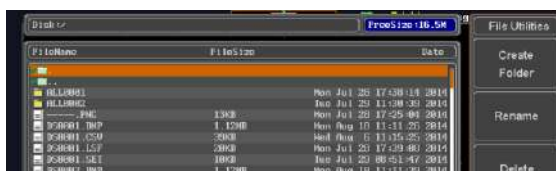

4. Press *Rename* when a file is chosen.

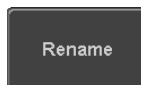

5. Use the *Variable* knob to highlight a character.



Press *Enter Character* or the *Select* key to select a number or letter.

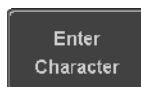

Press *Back Space* to delete a character.





6. Press *Save Now* to rename the folder or file.



## Delete File or Folder

Panel Operation

1. Press the *Utility* key.
2. Press *File Utilities* from the bottom menu.
3. Use the Variable knob and select key to navigate the file system to choose a file.

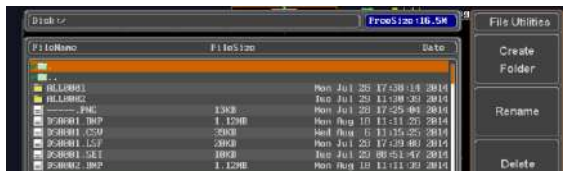

4. Press *Delete* to delete the selected file.
5. Press *Delete* again to confirm the deletion.

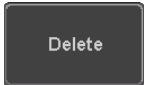
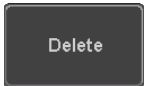

## Copy File to USB

- Panel Operation 1. Connect a USB drive to the front panel USB port.

Front Panel

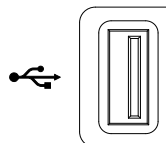

2. Press the *Utility* key.



3. Press *File Utilities* from the bottom menu.

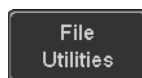

4. Use the *Variable* knob and *Select* key to navigate the file system to choose a file from internal memory.

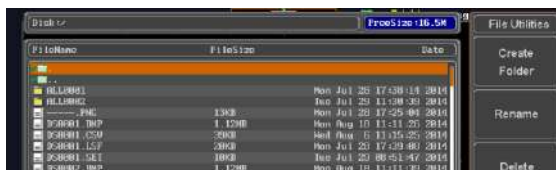

5. Press *Copy to USB* to copy the selected file to the USB drive.



If the same file name already exists on the USB drive, it will be copied over.

# HARDCOPY KEY

The Hardcopy key is used as quick-save or quick-print key. The Hardcopy key can be assigned either to printout screenshots or to save files.

When assigned to “Print” the screen image can be printed to a PictBridge compatible printer using the USB device port. To reduce the amount of printer ink used for each print, images can be printed using the Ink Saver function.

When assigned to “Save”, pressing the Hardcopy key can be used to save a screen shot, a waveform, or the current setup, depending on the configuration.

## Printer I/O Configuration

---

- Panel Operation
1. Connect a PictBridge printer to the USB device port on the rear panel.

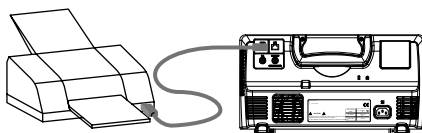

2. Press the *Utility* key.
3. Press *I/O* from the bottom menu.
4. Press *USB Device Port* from the side menu and select *Printer*.

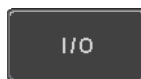

## Print Output

Ensure the USB port has been configured for the printer and the printer is connected to the scope before trying to print, see page 315.

Panel Operation 1. Press the *Utility* key.



2. Press *Hardcopy* from the bottom menu.

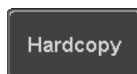

3. On the side menu, press *Function* and select *Print*.

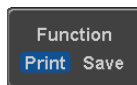

4. Press the *Hardcopy* key to print.  
The display image is printed out.

Hardcopy



Ink Saver

To have a white background on the printed display image, set *Ink Saver* to On.

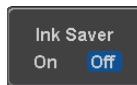

Ink Saver On

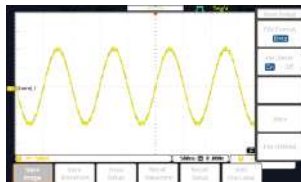

Ink Saver Off





## Save - Hardcopy Key

**Background** When the Hardcopy key is assigned to “Save”, pressing the Hardcopy key can be used to save a screen shot, a waveform, or the current setup, depending on the configuration.

- Panel Operation**
1. If you wish to save to USB, connect a USB drive to the front panel USB port, otherwise the file will save to internal memory.
 

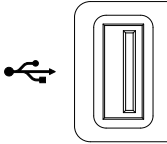
Front

  2. Press the *Utility* key.
 

  3. Press *Hardcopy* from the bottom menu.
 

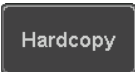
  4. On the side menu, press *Function* to select Save.
 

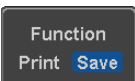
  5. Press *Assign Save To* and select which type of file will be saved when the Hardcopy key is pressed.
 



File Type: Image, Waveform, Setup, All
  6. Press the *Hardcopy* key to save the file\*.
 



- A message will appear when the save is successful.
- Image saved to USB : /DS0197.BMP.**

Image File Format

7. For image files the file format can be selected with the *File Format* key.

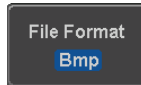

Format: BMP, PNG

Ink Saver

8. To have a white background for image files, set *Ink Saver* to On.

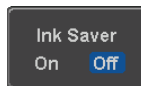

Ink Saver On



Ink Saver Off



Note

\*Each time the Hardcopy key is used to save waveforms or setup files, the files are saved into a new directory. The save directory is labeled ALLXXXX, where XXXX is a number that is incremented with each save. This directory is created in either the internal memory or to a USB flash drive.

# R

# REMOTE CONTROL

# CONFIG

This chapter describes basic configuration for remote control. For a complete command list, refer to the programming manual downloadable from GW Instek website, [www.gwinstek.com](http://www.gwinstek.com).



---

Interface Configuration .....	320
Configure USB Interface.....	320
USB Functionality Check.....	321
Configure the Ethernet Interface .....	322
Configure Socket Server.....	324
Socket Server Functionality Check.....	325

## Interface Configuration

### Configure USB Interface

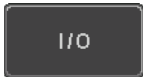
USB Configuration	PC side connector	Type A, host
	MSO-2000E/2000EA side connector	Type B, device
	Speed	1.1/2.0
	USB Class	CDC (communications device class)

- Panel Operation
1. Press the Utility key. 
  2. Press *I/O* from the bottom menu. 
  3. Press *USB Device Port* from the side menu and select *Computer*. 
  4. Connect the USB cable to the rear panel device port. 
  5. When the PC asks for the USB driver, select the USB driver included on the accompanying User Manual CD or download the driver from the GW Instek website, [www.gwinstek.com](http://www.gwinstek.com), in the MSO-2000E Download section. The driver automatically sets the MSO-2000E/2000EA as a serial COM port (Shown as VPO in the PORTS node).



## USB Functionality Check

---

### Terminal Application

Invoke a terminal application such as RealTerm.

Set the COM port, baud rate, stop bit, data bit, and parity accordingly.

To check the COM port number and associated port settings, see the Device Manager in the PC. For Windows 7:

*Control panel* → *Hardware and Sound* → *Device Manager*

Example: Configuring RealTerm:

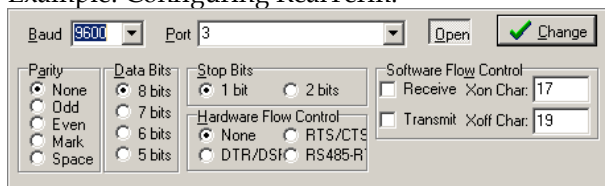

### Functionality Check

Key in this query command via the terminal application.

\*idn?

This should return the Manufacturer, Model number, Serial number, and Firmware version in the following format.

*GW,MSO-2xxxE,PXXXXXX,V1.00*





Note

For further details about remote control and remote commands, please see the programming manual, available on the GW Instek website.

## Configure the Ethernet Interface

Ethernet Configuration	MAC Address	Domain Name
	Instrument Name	DNS IP Address
	User Password	Gateway IP Address
	Instrument IP Address	Subnet Mask
		HTTP Port 80 (fixed)

**Background** The Ethernet interface is used for remote control using a socket server connection. For details, please see the Socket Server section on page 324.

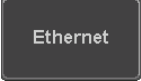
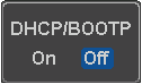
- Panel Operation**
1. Connect the Ethernet cable to the LAN port on the rear panel. 
  2. Press the *Utility* key. 
  3. Press *I/O* from the bottom menu. 
  4. Press *Ethernet* from the side menu. 
  5. Set *DHCP/BOOTP* to *On* or *Off* from the side menu. 

 **Note**

IP addresses will automatically be assigned with DHCP/BOOTP set to on. For Static IP Addresses, DHCP/BOOTP should be set to off.

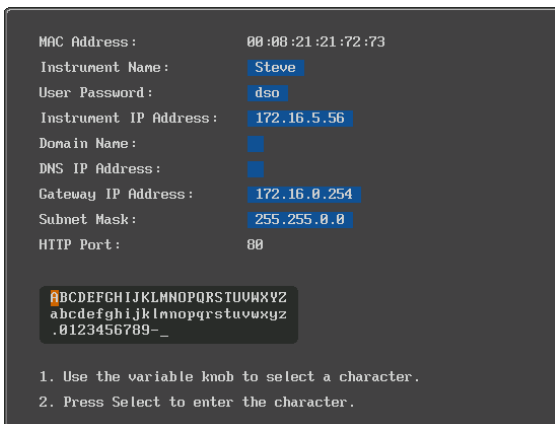

6. Use the *Up* and *Down* arrows on the side menu to navigate to each Ethernet configuration item.

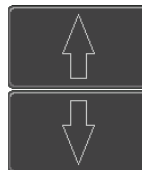

Items      MAC Address, Instrument Name, User Password, Instrument IP Address, Domain Name, DNS IP Address, Gateway IP Address, Subnet Mask

Note: HTTP Port is fixed at 80.

7. Use the *Variable* knob to highlight a character and use the *Select* key to choose a character.

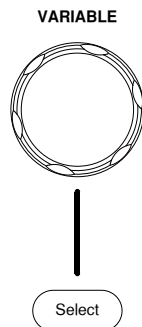

Press *Backspace* to delete a character.



Press *Save Now* to save the configuration. Complete will be displayed when successful.

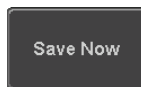

## Configure Socket Server

The MSO-2000E/2000EA supports socket server functionality for direct two-way communication with a client PC or device over LAN. By default, the Socket Server is off.

Configure Socket Server

1. Configure the IP address for the MSO-2000E/2000EA.

Page 322

2. Press the *Utility* key.



3. Press *I/O* from the bottom menu.

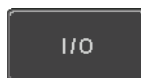

4. Press *Socket Server* from the side menu.

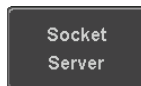

5. Press *Select Port* and choose the port number with the Variable knob.



Range 1024~65535

6. Press *Set Port* to confirm the port number.

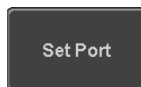

7. The Current Port icon will update to the new port number.



- Press *Server* and turn the socket server On.

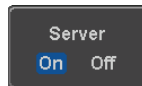

## Socket Server Functionality Check

---

NI Measurement and Automation Explorer To test the socket server functionality, National Instruments Measurement and Automation Explorer can be used. This program is available on the NI website, [www.ni.com](http://www.ni.com).

- |           |  |   |
|-----------|--|---|
| Operation | 1. Configure the IP address for the MSO-2000E/2000EA.                                    | Page 322  |
|           | 2. Configure the socket port.  | Page 324  |
|           | 3. Start the NI Measurement and Automation Explorer (MAX) program. Using Windows, press: |  |

*Start>All Programs>National Instruments>Measurement & Automation*



- From the Configuration panel access;

*My System>Devices and Interfaces>Network Devices*

- Right click *Network Devices* and select *Create New Visa TCP/IP Resource...*

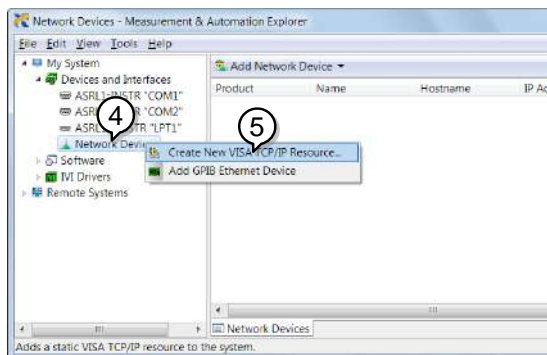

- Select *Manual Entry of Raw Socket* from the popup window.
- Click *Next*.



- Enter the MSO-2000E/2000EA's IP address and socket port number.
- Click *Validate*.
- A popup will appear to tell you if a VISA socket

session was successfully created.

11. Click *Next*.



12. Choose an alias for the socket connection if you like.

13. Click *Finish* to finish the configuration.



14. The MSO-2000E/2000EA will now appear under Network Devices in the Configuration Panel.

Functionality  
Check

15. Click the *Open Visa Test Panel* to send a remote command to the MSO-2000E/2000EA.

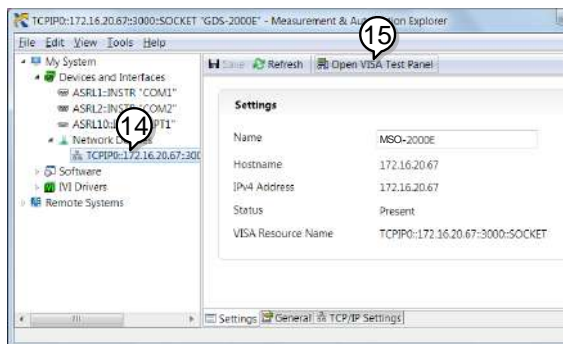

16. Click on the *Configuration* icon.

17. Select the *I/O Settings* tab.

18. Mark the *Enable Termination Character* checkbox. Make sure the termination character is a line feed (/n, value: xA).

19. Click *Apply Changes*.





20. Click the *Input/Output* icon.
21. Make sure the *\*IDN?* query is selected in the *Select or Enter Command* drop box.
22. Click on *Query*.
23. The manufacturer, model number, serial number and firmware version will be displayed in the buffer. For example:  
GW,MSO-2202E,PXXXXXX,V1.00



Note

For further details about remote control and remote commands, please see the programming manual.

# M AINTENANCE

Three types of maintenance operations are available: Signal Path Compensation, Vertical Accuracy Calibration and Probe Compensation. Run these operations when using the MSO-2000E/2000EA in a new environment.



---

How to use the SPC function .....	331
Vertical Accuracy Calibration.....	332
Probe Compensation .....	333

## How to use the SPC function

---

**Background** Signal Path Compensation (SPC) is used to compensate the internal signal path due to ambient temperature. SPC is able to optimize the accuracy of the oscilloscope with respect to the ambient temperature.

- Panel Operation**
1. Press the *Utility* key. 
  2. Press *System* from the bottom menu. 
  3. Press *SPC* from the side menu. A message showing a brief introduction to SPC appears on the screen. 



Note

Disconnect all probes and cables from all channels before calibrating.

The DSO needs to be warmed up for at least 30 minutes before using the SPC function.

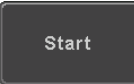
4. Press *Start* on the side menu to start SPC calibration. 
5. The SPC Calibration will proceed one channel at a time, from channel 1 to channel 4\*.

\*Channels 1 to 2 for 2 channel models only.

## Vertical Accuracy Calibration

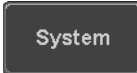
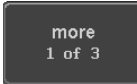
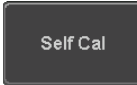
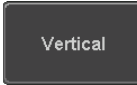
- Panel Operation
1. Press the *Utility* key. 
  2. Press *System* from the bottom menu. 
  3. Press *more 1 of 3* from the side menu. 
  4. Press *Self Cal* on the side menu. 
  5. Press *Vertical* on the side menu. 
  6. A message appears to “Now performing vertical calibration...  
CH1  
Connect the CAL output to channel, then press the Vertical key”.
  7. Connect the calibration signal from the rear panel to the Channel 1 input with a BNC cable.

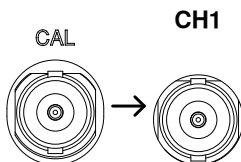

8. Press *Vertical* again after connecting CAL to the channel 1 input.

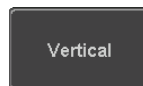

The calibration for Channel 1 starts and ends automatically, in less than 5 minutes. A message is displayed when the calibration procedure has ended.

9. Repeat the above step for Channel 2, 3\* and 4\* when prompted.

\*4 channel models only.

10. When the calibration for all channels has completed, the display goes back to the default state.

## Probe Compensation

---

- Panel Operation
1. Connect the probe between the Channel 1 input and the probe compensation output (default set as 2V<sub>p-p</sub>, 1kHz square wave) on the front panel. Set the probe attenuation to x10.
  2. Alternatively, the probe compensation frequency can be changed. See page 205 for details.

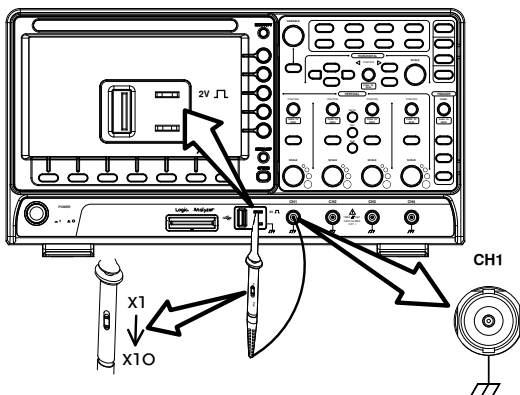

3. Press the *CH1* key to activate CH1.



4. Set the *Coupling* to DC from the bottom menu.



5. Set the Probe attenuation to *Voltage, 10X*.

Page 122

6. Press the *Autoset* key. The compensation signal appears on the display.



7. Press the *Display* key, then set the display type to *Vector*.

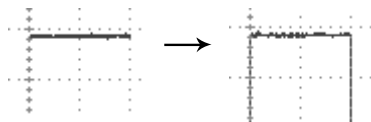
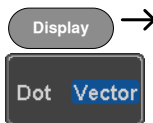

8. Turn the adjustment point on the probe to make the waveform as square as possible.

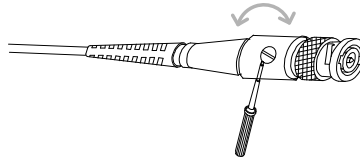
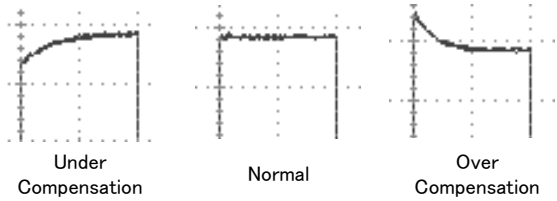

# FAQ

---

- I connected the signal but it does not appear on the display.
- I want to remove the (Measurement result / FFT result / Help contents) from the display.
- The waveform does not update (frozen).
- The probe waveform is distorted.
- Autoset does not catch the signal well.
- The display image printout is too dark on the background.
- The date and time settings are not correct.
- The accuracy does not match the specification.

## I connected the signal but it does not appear on the display.

---

Make sure you have activated the channel by pressing the Channel key (the channel key lights up).

## I want to remove the (Measurement result / FFT result / Help contents) from the display.

---

To clear automatic measurement results, press the Measure key, select Remove Measurement and choose Remove All. See page 57.

To clear individual measurements from the screen, press the Measure key, select Display All and choose Off. See page 58.

To clear the FFT result, press the Math key twice. See page 73 for details.

To clear the Help result, press the Help key again. See page 41 for details.



The waveform does not update (frozen).

---

Press the Run/Stop key to unfreeze the waveform. See page 46 for details.

If this does not help, the trigger mode might be set to Single. Press the Single key to exit Single mode. See page 154 for Single trigger details.

The probe waveform is distorted.

---

You might need to compensate the probe. For details, see page 333.

Autoset does not catch the signal well.

---

The Autoset function cannot catch signals under 10mV or 20Hz. Please use the manual operation. See page 44 for Autoset details.

The display image printout is too dark on the background.

---

Use the Ink Saver function which reverses the background color. For details, see page 316.

The date and time settings are not correct.

---

For date and time setting details, please see page 204. If it does not help, the internal battery controlling the clock might be worn out. Contact your dealer or GW Instek.

The accuracy does not match the specification.

---

Make sure the device is powered On for at least 30 minutes, within +20°C~+30°C. This is necessary to stabilize the unit to match the specification.

For more information, contact your local dealer or GW Instek at [www.gwinstek.com](http://www.gwinstek.com) / [marketing@goodwill.com.tw](mailto:marketing@goodwill.com.tw).

# A PPENDIX

---

Updating the Firmware .....	340
MSO-2000E/2000EA Specifications ....	342
Model-specific .....	342
Common .....	343
Probe Specifications .....	347
Dimensions .....	349
Declaration of Conformity .....	350

## Updating the Firmware

**Background** New firmware can be downloaded from the GW Instek website in the MSO products section.

Place a copy of the firmware onto the root directory of a USB memory stick.

**Panel Operation** 1. Put the USB drive that contains the firmware into the front panel USB port.

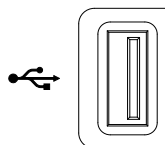

2. Press the *Utility* key.



3. Press *File Utilities* from the bottom menu.

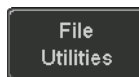

4. Use the *Variable* knob to highlight the upgrade file.

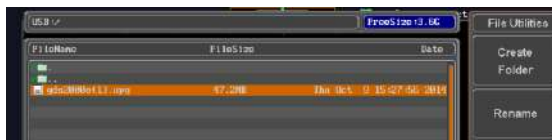

5. Press the *Select* key to begin the installation of the upgrade file.



6. A message will appear asking you to confirm this process.

Press the *Select* key again to confirm the installation of the firmware.



Alternatively, press any other key to cancel the installation.

7. Wait for the installation process to complete. When the installation has completed you will be prompted to restart the oscilloscope. Remove the USB drive and proceed to the restart.

## MSO-2000E/2000EA Specifications

The specifications apply when the MSO-2000E/2000EA is powered on for at least 30 minutes under +20°C~+30°C.

### Model-specific

MSO-2072E / 2072EA	Channels	2 + Ext
	Bandwidth	DC ~ 70MHz (-3dB)
	Rise Time	5ns
	Bandwidth Limit	20MHz
MSO-2074E / 2074EA	Channels	4
	Bandwidth	DC ~ 70MHz (-3dB)
	Rise Time	5ns
	Bandwidth Limit	20MHz
MSO-2102E / 2102EA	Channels	2 + Ext
	Bandwidth	DC ~ 100MHz (-3dB)
	Rise Time	3.5ns
	Bandwidth Limit	20MHz
MSO-2104E / 2104EA	Channels	4
	Bandwidth	DC ~ 100MHz (-3dB)
	Rise Time	3.5ns
	Bandwidth Limit	20MHz
MSO-2202E / 2202EA	Channels	2 + Ext
	Bandwidth	DC ~ 200MHz (-3dB)
	Rise Time	1.75ns
	Bandwidth Limit	20MHz/100MHz
MSO-2204E / 2204EA	Channels	4
	Bandwidth	DC ~ 200MHz (-3dB)
	Rise Time	1.75ns
	Bandwidth Limit	20MHz/100MHz

**Common**

Vertical Sensitivity	Resolution	8 bit :1mV*~10V/div *: When the vertical scale is set to 1mV/div, the bandwidth limit will be set to 20MHz automatically.	
	Input Coupling	AC, DC, GND	
	Input Impedance	1MΩ// 16pF approx.	
	DC Gain Accuracy*	1mV: ±5% full scale ≥2mV: ±3% full scale	
	Polarity	Normal & Invert	
	Maximum Input Voltage	300Vrms, CAT I	
	Offset Position Range	1mV/div ~ 20mV/div : ±0.5V 50mV/div ~ 200mV/div : ±5V 500mV/div ~ 2V/div : ±25V 5V/div ~ 10V/div : ±250V	
	Waveform Signal Process	+, -, ×, ÷, FFT, FFTrms, User Defined Expression FFT: Spectral magnitude. Set FFT Vertical Scale to Linear RMS or dBV RMS, and FFT Window to Rectangular, Hamming, Hanning, or Blackman-Harris.	
	Trigger	Source	CH1, CH2, CH3*, CH4*, Line, EXT**, D0-D15 *four channel models only. **two channel models only.
		Trigger Mode	Auto (supports Roll Mode for 100 ms/div and slower), Normal, Single Sequence
Trigger Type		Edge, Pulse Width (Glitch), Video, Pulse Runt, Rise & Fall (Slope), Timeout, Alternate, Event-Delay (1~65535 events), Time-Delay (Duration, 4nS~10S), Bus	
Holdoff range		4nS to 10S	
Coupling		AC, DC, LF rej., Hf rej., Noise rej.	
Sensitivity		1div	
External Trigger	Range	±15V	
	Sensitivity	DC ~ 100MHz Approx. 100mV 100MHz ~ 200MHz Approx. 150mV	
	Input Impedance	1MΩ±3%~16pF	
Horizontal	Time base Range	1ns/div ~ 100s/div (1-2-5 increments) ROLL: 100ms/div ~ 100s/div	
	Pre-trigger	10 div maximum	

	Post-trigger	2,000,000 div maximum.
	Timebase Accuracy	±50 ppm over any ≥ 1 ms time interval
	Real Time Sample Rate	1GSa/s max. (4ch models); 1GSa/s per channel (2ch models)
	Record Length	Max. 10Mpts
	Acquisition Mode	Normal, Average, Peak Detect, Single
	Peak Detection	2nS (typical)
	Average	selectable from 2 to 256
X-Y Mode	X-Axis Input	Channel 1; Channel 3* *four channel models only
	Y-Axis Input	Channel 2; Channel 4* *four channel models only
	Phase Shift	±3° at 100kHz
Cursors and Measurement	Cursors	Amplitude, Time, Gating available; Unit: Seconds(s), Hz (1/s), Phase (degree), Ratio (%).
	Automatic Measurement	38 sets: Pk-Pk, Max, Min, Amplitude, High, Low, Mean, Cycle Mean, RMS, Cycle RMS, Area, Cycle Area, ROVShoot, FOVShoot, RPREShoot, FPREShoot, Frequency, Period, RiseTime, FallTime, +Width, -Width, Duty Cycle, +Pulses, -Pulses, +Edges, -Edges, %Flicker, Flicker Idx, FRR, FRF, FFR, FFF, LRR, LRF, LFR, LFF, Phase.
	Cursors measurement	Voltage difference between cursors ( ΔV) Time difference between cursors ( ΔT)
	Auto counter	6 digits, range from 2Hz minimum to the rated bandwidth
Control Panel Function	Autoset	Single-button, automatic setup of all channels for vertical, horizontal and trigger systems, with undo Autoset
	Save Setup	20set
	Save Waveform	24set
AWG	General:	
	Channels	2
	Sample Rate	200MSa/s
	Vertical Resolution	14 bits
	Max. Frequency	25 MHz
	Standard Waveforms	Sine, Square, Pulse, Ramp, DC, Noise
	Built-in Waveforms	Sinc, Gaussian, Lorentz, Exponential Rise, Exponential Fall, Haversine, Cardiac
	Output Range	20 mVpp to 5 Vpp, HighZ 10 mVpp to 2.5 Vpp, 50Ω
	Output Resolution	1mV



	Output Accuracy	2% (1 kHz)
	Offset Range	±2.5 V, HighZ
	Sine:	
	Frequency Range	100 mHz to 25 MHz
	Flatness	±0.5 dB (relative to 1 kHz)
	Harmonic Distortion	-40 dBc
	Stray (Non-harmonic)	-40 dBc
	Total Harmonic Distortion	1%
	S/N Ratio	40 dB
	Square/Pulse:	
	Frequency Range	Square: 100 mHz to 15 MHz
	Rise/Fall Time	< 15ns
	Overshoot	< 3 %
	Duty Cycle	Square: 50% Pulse: 0.4% to 99.6%
	Min. Pulse Width	20ns
	Jitter	500 ps
	Ramp:	
	Frequency Range	100 mHz to 1MHz
	Linearity	1%
	Symmetry	0 to 100%
Logic Analyzer	Sample Rate	1GSa/s
	Bandwidth	200MHz
	Record Length	Per Channel 10M points (max)
	Total Memory	2G bits
	Input Channels	16 Digital (D15 - D0)
	Trigger type	Edge, Pattern, Pulse Width, Serial bus (I2C, SPI, UART, CAN, LIN), Parallel Bus
	Thresholds Quad	Settable thresholds for: D0-D3, D4-D7, D8-11, D12-15
	Threshold selections	TTL, CMOS(5V,3.3V,2.5V), ECL, PECL,0V, User Defined
	User-defined Threshold Range	±5V
	Maximum Input Voltage	±40 V
	Minimum Voltage Swing	±250 mV
	Vertical Resolution	1 bit
Display	TFT LCD Type	8" TFT LCD WVGA color display
	Display Resolution	800 horizontal × 480 vertical pixels (WVGA)
	Interpolation	Sin(x)/x
	Waveform Display	Dots, vectors, variable persistence (16ms~4s), infinite persistence

	Waveform Update Rate	120,000 waveforms per second, maximum
	Display Graticule	8 x 10 divisions
	Display Mode	YT, XY
Interface	USB Port	USB 2.0 High-speed host port X1, USB High-speed 2.0 device port X1
	Ethernet Port (LAN)	RJ-45 connector, 10/100Mbps with HP Auto-MDIX
	Go-NoGo BNC	5V Max/10mA TTL open collector output
	Kensington Style Lock	Rear-panel security slot connects to standard Kensington-style lock.
Miscellaneous	Multi-language menu	Available
	Operation Environment	Temperature: 0°C to 50°C. Relative Humidity ≤ 80% at 40°C or below; ≤ 45% at 41°C ~ 50°C.
	On-line help	Available
	Time clock	Time and Date, Provide the Date/Time for saved data
	Dimensions	380mmX208mmX127.3mm
	Weight	2.8kg

## Probe Specifications

### GTP-070B-4

Applicable to: MSO-2072E/2072EA & MSO-2074E/2074EA

Position x10	Attenuation Ratio	10:1
	Bandwidth	DC to 70MHz
	Input Resistance	10M $\Omega$ when used with oscilloscopes with 1M $\Omega$ input
	Input Capacitance	14.5pF to 17.5pF
	Compensation Range	10pF to 35pF
Position x1	Max. Input Voltage	$\leq 600V$ DC + ACpk
	Attenuation Ratio	1:1
	Bandwidth	DC to 10MHz
	Input Resistance	1M $\Omega$ (oscilloscope input resistance)
Operating Cond.	Input Capacitance	85pF to 115pF
	Max. Input Voltage	$\leq 200V$ DC + ACpk
	Temperature	-10°C to 50°C
Relative Humidity		$\leq 85\%$

### GTP-100B-4

Applicable to: MSO-2102E/2102EA & MSO-2104E/2104EA

Position X10	Attenuation Ratio	10:1
	Bandwidth	DC to 100MHz
	Input Resistance	10M $\Omega$ when used with oscilloscopes with 1M $\Omega$ input.
	Input Capacitance	14.5pF to 17.5pF
	Compensation Range	5pF to 30pF
Position X1	Max. Input Voltage	$\leq 600V$ DC + ACpk
	Attenuation Ratio	1:1
	Bandwidth	DC to 10MHz
	Input Resistance	1M $\Omega$ (oscilloscope input resistance)
Operating Cond.	Input Capacitance	85pF to 115pF
	Max. Input Voltage	$\leq 200V$ DC + ACpk
	Temperature	-10°C to 50°C
Relative Humidity		$\leq 85\%$

**GTP-200B-4**

Applicable to: MSO-2202E/2202EA & MSO-2204E/2204EA

Position X10	Attenuation Ratio	10:1
	Bandwidth	DC to 200MHz
	Input Resistance	10MΩ when used with oscilloscopes with 1MΩ input.
	Input Capacitance	10.5pF to 17.5pF
	Compensation Range	5pF to 30pF
	Max. Input Voltage	≤600V DC + ACpk
Position X1	Attenuation Ratio	1:1
	Bandwidth	DC to 10MHz
	Input Resistance	1MΩ (oscilloscope input resistance)
	Input Capacitance	65pF to 105pF
	Max. Input Voltage	≤200V DC + ACpk
Operating Cond.	Temperature	-10°C to 50°C
	Relative Humidity	≤85%

# Dimensions

---

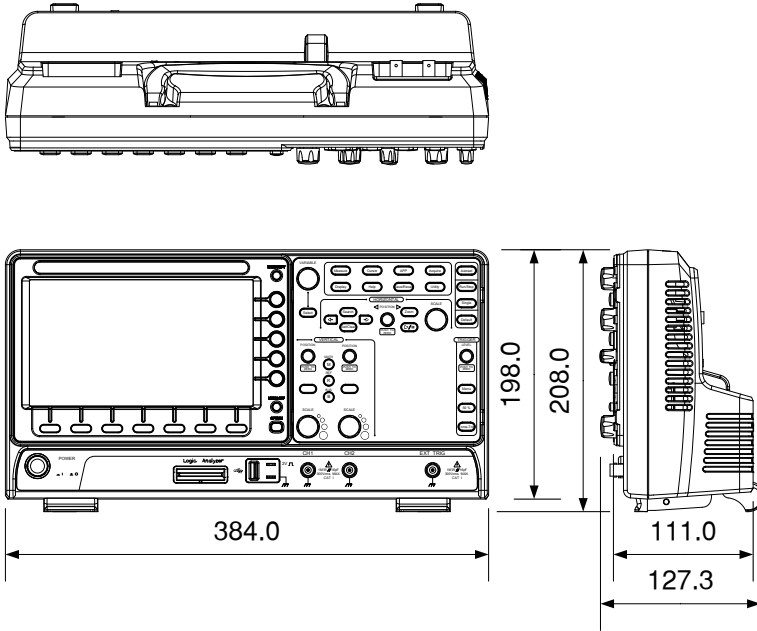

## Declaration of Conformity

We

**GOOD WILL INSTRUMENT CO., LTD.**

declare that the below mentioned product

**Type of Product:** Mixed-signal oscilloscope

**Model Number:** MSO-2072E, MSO-2072EA, MSO-2074E, MSO-2074EA,  
MSO-2102E, MSO-2102EA, MSO-2104E, MSO-2104EA,  
MSO-2202E, MSO-2202EA, MSO-2204E, MSO-2204EA

are herewith confirmed to comply with the requirements set out in the Council Directive on the Approximation of the Law of Member States relating to Electromagnetic Compatibility (2014/30/EU) and Low Voltage Equipment Directive (2014/35/EU).

For the evaluation regarding the Electromagnetic Compatibility and Low Voltage Directive, the following standards were applied:

© EMC	
EN 61326-1 : EN 61326-2-1:	Electrical equipment for measurement, control and laboratory use — EMC requirements (2013)
Conducted and Radiated Emissions EN 55011:2009+A1:2010	Electrical Fast Transients EN 61000-4-4:2012
Current Harmonic EN 61000-3-2:2006+A1:2009+A2:2009	Surge Immunity EN 61000-4-5: 2006
Voltage Fluctuation EN 61000-3-3:2013	Conducted Susceptibility EN 61000-4-6: 2009
Electrostatic Discharge EN 61000-4-2: 2009	Power Frequency Magnetic Field EN 61000-4-8:2010
Radiated Immunity EN 61000-4-3:2006+A1:2008+A2:2010	Voltage Dips/ Interrupts EN 61000-4-11: 2004
Low Voltage Equipment Directive 2014/35/EU	
Safety Requirements	EN 61010-1:2010 (Third Edition) EN 61010-2-030:2010 (First Edition)

**GOODWILL INSTRUMENT CO., LTD.**

No. 7-1, Jhongsing Road, Tucheng District, New Taipei City 236, Taiwan

Tel: [+886-2-2268-0389](tel:+886-2-2268-0389)

Fax: [+886-2-2268-0639](tel:+886-2-2268-0639)

Web: <http://www.gwinstek.com>

Email: [marketing@goodwill.com.tw](mailto:marketing@goodwill.com.tw)

**GOODWILL INSTRUMENT (SUZHOU) CO., LTD.**

No. 521, Zhujiang Road, Snd, Suzhou Jiangsu 215011, China

Tel: [+86-512-6661-7177](tel:+86-512-6661-7177)

Fax: [+86-512-6661-7277](tel:+86-512-6661-7277)

Web: <http://www.instek.com.cn>

Email: [marketing@instek.com.cn](mailto:marketing@instek.com.cn)

**GOODWILL INSTRUMENT EURO B.V.**

De Run 5427A, 5504DG Veldhoven, The Netherlands

Tel: [+31-\(0\)40-2557790](tel:+31-(0)40-2557790)

Fax: [+31-\(0\)40-2541194](tel:+31-(0)40-2541194)

Email: [sales@gw-instek.eu](mailto:sales@gw-instek.eu)

# I NDEX

- AC coupling ..... 117
- AC Priority mode ..... 45
- Acquisition ..... 86
  - average.....86
  - indicator.....29
  - peak detect .....86
  - record length.....89
  - sample.....86
  - XY mode .....87
- Advanced math
  - expression.....78
  - operation.....79
  - source .....78
- Amplitude measurements ..... 51
- APP
  - Data Log .....268
  - digital filter.....270
  - DVM.....266
  - Go-NoGo .....261
  - mask .....272
  - overview .....259
  - run .....260
- Area measurements..... 51
- Auto trigger..... 155
- Auto-dim ..... 105
- Automatic measurement
  - Add measurement.....54
  - display all .....58
  - gated mode.....57
  - High-Low .....59
  - overview .....50
  - Reference levels .....63
  - remove measurement.....57
  - Statistics .....61
- Autoset..... 44
  - AC Priority mode .....45
  - effect on channel.....45
  - exception.....45
  - Fit Screen mode .....45
- AWG
  - AM.....233
  - channel activation .....227
  - connection.....226
  - Coupling and tracking .....254
  - Create new ARB waveform .....241
  - edit existing waveform.....243
  - FM.....235
  - FSK.....237
  - function edit.....246
  - impedance.....228
  - load ARB waveform .....250
  - normal edit .....245
  - overview .....224
  - phase.....228
  - Save ARB waveform.....252
  - select waveform .....229
  - specification.....344
  - sweep.....239
  - turn on output .....228
  - waveform settings.....230
- Bandwidth filter ..... 119
- Blackman window .....76
- Built-in help ..... 41
- Bus
  - CAN.....134
  - cursors .....149
  - encoding.....140
  - event tables .....142, 146
  - I<sup>2</sup>C .....130
  - labels.....147
  - LIN.....136
  - parallel.....138
  - serial bus overview .....126
  - SPI .....132
  - threshold .....140
  - trigger settings
    - CAN.....182
    - I<sup>2</sup>C .....177
    - LIN .....185

Parallel.....	187	pollution degree.....	9
SPI.....	181	Erase memory.....	203
UART.....	176	Ethernet	
UART.....	128	interface.....	322
Channel.....	43	Expand by ground/center.....	120
status indicator.....	30	External trigger.....	154
Control panel function		input terminal.....	24
specification.....	344	specification.....	343
Conventions.....	36	FAQ.....	336
Coupling mode.....	117	FFT	
Cursor		horizontal cursor.....	67
horizontal.....	65	vertical cursor.....	70
specification.....	344	File	
vertical.....	69	create folder.....	311
Data logging.....	268	delete.....	313
Date setting.....	204	rename.....	312
indicator.....	29	File navigation.....	309
DC coupling.....	117	File path.....	310
Declaration of conformity.....	350	Firmware update.....	340
Default setup.....	301	Firmware version.....	203
contents.....	301	First time use.....	33
effect on channel.....	44	Fit Screen mode.....	45
Delay measurements.....	53	Frequency measurements.....	52
Deskew.....	122	Front panel diagram.....	18, 19
Digital channels		Go-NoGo	
activation.....	211	circuit diagram.....	265
analog waveform.....	219	Go-NoGo.....	261
grouping.....	213	timing.....	265
labels.....	220	Ground	
position.....	213	coupling.....	118
threshold.....	217	terminal.....	25
vertical scale.....	217	Hamming window.....	76
Digital filter.....	270	Hanning window.....	75
Dimensions		Holdoff.....	161
diagram.....	349	Horizontal	
Display		basic operation.....	47
AWG.....	226	position.....	108
bus.....	124	scale.....	109
logic analyzer.....	210	specification.....	343
search.....	193	Image file format.....	283
segmented memory.....	93	Impedance.....	118
specification.....	345	Initialization.....	33
Dots.....	103	Input frequency indicator.....	29
DVM.....	266	Intensity.....	104
Edge Trigger.....	162	Interface.....	320
EN61010		specification.....	346
measurement category.....	8		



- Invert waveform ..... 118
- Keys overview ..... 19
- Labels ..... 289
- Language selection ..... 202
- List of features ..... 15
- Logic Analyzer
  - overview ..... 208
  - probes ..... 209
  - specification ..... 345
- Logic trigger ..... 188
- Mask ..... 272
  - auto mask ..... 274
  - user-defined mask ..... 277
- Math
  - Advanced math overview ..... 78
  - basic ..... 73
  - FFT operation ..... 76
  - FFT overview ..... 75
- Mean measurements ..... 51
- Memory bar
  - indicator ..... 29
- Menu on/off ..... 107
- Miscellaneous
  - specification ..... 346
- Model differences ..... 14
- Normal trigger ..... 155
- NTSC ..... 158
- On-screen help ..... 41
- Overshoot measurements ..... 52
- PAL ..... 158
- Peak measurements ..... 50
- Peak to peak measurement ..... 50
- Persistence ..... 103
- Play waveform ..... 113
- Printing
  - connection ..... 315
  - hardcopy key ..... 316
  - ink saver ..... 316
- Probe
  - attenuation level ..... 122
  - attenuation type ..... 121
  - deskew ..... 122
- Probe compensation ..... 333
- Probe compensation frequency ..... 205
- Pulse runt trigger ..... 170
- Pulse measurements ..... 52
- Pulse width trigger ..... 166
- QR code reader function ..... 205
- Rear panel diagram ..... 26, 225
- Recall ..... 300
  - default setup ..... 301
  - reference ..... 306
  - setup ..... 304
  - waveform ..... 303
- Rectangular window ..... 76
- Reduce any menu ..... 39
- Reduce lower menu ..... 39
- Reduce side menu ..... 38
- Remote control ..... 319
  - interface configuration ..... 320
- Rise and fall trigger ..... 172
- RMS measurements ..... 51
- Roll mode ..... 110
- RS-232C
  - function check ..... 321
- Run/Stop ..... 46, 106
  - horizontal position ..... 108
  - Horizontal scale ..... 109
- Safety Instructions
  - Caution symbol ..... 7
  - Cleaning the instrument ..... 9
  - Disposal instructions ..... 10
  - Ground symbol ..... 7
  - Operation Environment ..... 9
  - Power on/off ..... 9
  - UK power cord ..... 11
  - Warning symbol ..... 7
- Save ..... 292
  - hardcopy key ..... 317
  - image ..... 293
  - setup ..... 297
  - waveform ..... 295
- Screen dimmer ..... 105
- Search
  - configuration ..... 193
  - copying search events ..... 195
  - copying trigger events ..... 195
  - FFT Peak ..... 198
  - navigation ..... 195
  - save marks ..... 196
  - set/clear events ..... 197
- SECAM ..... 159
- Segmented memory

configuration .....	94	indicator .....	29
infomation.....	102	logic .....	188
measurement .....	98	mode.....	162
navigation .....	97	parameters.....	154
overview.....	91	pulse runt.....	170
play back .....	97	pulse width.....	166
run.....	95	Rise and fall .....	172
Serial number.....	203	Single.....	46
Service operation		specification.....	343
about disassembly.....	8	status indicator.....	30
contact.....	338	Timeout.....	173
Setup		overview .....	160
default contents .....	301	video.....	169
file format.....	286	Updating the firmware .....	340
Signal path compensation .....	331	USB	
Single trigger mode.....	155	function check.....	321
Run/Stop.....	46	remote control interface .....	320
Socket server		Vectors.....	103
function check.....	325	Vertical .....	116
Socket server		accuracy calibration.....	332
interface.....	324	basic operation .....	49
SPC .....	331	position .....	116
Specifications .....	342	scale .....	117
Spreadsheet file format.....	284	specification.....	343
Stop icon .....	46	Video trigger .....	169
System information.....	203	Waveform	
Tilt stand.....	31	CSV file contents.....	285
Time setting.....	204	file contents.....	284
indicator .....	29	how to recall.....	303
Trigger .....	151	how to save.....	295
Bus		invert waveform .....	118
CAN.....	182	play/pause key .....	113
PC.....	177	roll mode.....	110
LIN.....	185	zoom mode .....	111
Parallel.....	187	Waveform color .....	28
SPI .....	181	Waveform file format.....	283
UART.....	176	XY	
edge.....	162	specification.....	344
holdoff.....	161	Zoom waveform .....	111